

2238 Mediator

Integrating Sound Level Meter
Basic SLM Software BZ 7126

August 1998

Trademarks

2238 Mediator is a trademark of Brüel & Kjær A/S. Microsoft, Windows, and MS-DOS are trademarks of Microsoft Corporation.

Copyright © 1998, Brüel & Kjær Sound & Vibration Measurement A/S

All rights reserved. No part of this publication may be reproduced or distributed in any form, or by any means, without prior consent in writing from Brüel & Kjær Sound & Vibration Measurement A/S, Nærum, Denmark.

Contents

Introduction

About this manual and the 2238 Mediator. Overview of measurement parameters, menus and navigation

1

Getting Started

Basic introduction to the Mediator: Fitting batteries, pushkey definitions, Measurement Window and changing the language

2

The System Menu

Explains how to set up parameters in the System menu

3

The Measurement Set-up Menu

Explains how to set up parameters in the Measurement Set-up menu

4

Measuring

Explains how to perform simple measurements: Calibrating, starting a new measurement, measurement control and changing the displayed measurement parameters

5

Data Handling

Explains how the data file system works: Storing, recalling, printing and deleting data

6

Printing and Transferring Data

Explains how to export data to a PC and post-processing programs, how to set up a printer

7

Maintenance and Repair

Service, repair, care, cleaning and storage of the Mediator

8

9

Specifications

Specifications for the Mediator

10

Appendix 1: General

Information about: Exchange Rate, listing of default parameters and interface error messages

11

Appendix 2: Interface

Explains the programming and operation of the serial interface for the Mediator: Formats for interface messages, setting up the PC and interface jobs

Index

Chapter 1

Introduction

1.1	About this Manual	1-2
	Summary of Contents.....	1-2
	About this Volume.....	1-3
1.2	About the 2238 Mediator	1-4
	How the Mediator Works	1-5
	Application Programs.....	1-5
1.3	Measurement Parameters.....	1-7
1.4	Menu Structure.....	1-10
	Navigation.....	1-10
	System Menu	1-11
	Measurement Set-up Menu	1-11
	Calibration Menu	1-12
	File System	1-12
1.5	Backlight	1-14

1.1 About this Manual

1.1.1 Summary of Contents

- **Chapter 1 – Introduction:** provides a general overview of the Mediator and its functions.
- **Chapter 2 – Getting Started:** provides basic information including: replacing batteries, using the pushkeys, reading the screen, and setting the language.
- **Chapter 3 – System Menu:** provides an overview of the System menu and gives instructions for setting up the parameters.
- **Chapter 4 – Measurements Set-up Menu:** provides an overview of the Measurement Set-up menu and gives instructions for setting up the measurement parameters.
- **Chapter 5 – Measuring:** gives instructions for calibrating the Mediator and for checking the calibration and the calibration history. It provides information about starting a new measurement.
- **Chapter 6 – Data Handling:** contains information and instructions about using the file managing system.
- **Chapter 7 – Printing and Transferring Data:** provides information about outputting data to a printer or a PC and setting up the output connectors.
- **Chapter 8 – Maintenance and Repair:** gives information about care, cleaning and storage and contains service and repair information.
- **Chapter 9 – Specifications:** – technical specifications.
- **Appendix 1: General:** – describes the exchange rate parameter and lists the default parameters and interface error messages.
- **Appendix 2: Interface:** – gives a general description of the terminology for the interface messages and instructions for using the interface commands and queries
- **Index**

1.1.2 About this Volume



This volume of the User Manual deals with all the general aspects of handling and setting up the Mediator and includes instructions for the functionality of the Basic version (Basic SLM Software BZ 7126). If your Mediator has been upgraded to other version(s), you must refer to the associated User Manual(s) for the special functions related to these software versions.

Conventions Used in this Manual

Pushkeys

References to buttons on the 2238 Mediator are shown with the pushkey's pictogram as it appears on the instrument (for example ). Refer to section 2.3 for a complete list of button pictograms and their functions.

Soft Keys

Mediator has two “soft keys” that have different functions depending on the current context. The soft keys functions are denoted by chevrons (<>) and courier type face. The current functions of the soft keys are always shown on the display. The  soft key can have the following functions: <Select>, <Save>, <Ok> or <Menu>. The  soft key can have functions: <Cancel>, <Undo> or <Close>. This is similar to the functionality from the familiar Windows® environment.

Parameter Text

Text which refers directly to text on the instrument's screen or printouts is indicated using a Courier type face.

For example: Press  until Language is highlighted in the System menu.

Sockets

Reference to sockets is made in bold type face (for example, **Aux 1**)

1.2 About the 2238 Mediator

Standards

2238 Mediator Integrating Sound Level Meter complies with the coming IEC 1672 Class 1 standard. This standard will supersede the IEC 651 and IEC 804 Type 1 standards. This implies that the Mediator also complies with current international and national standards. The Mediator is categorized as a Group X sound level meter according to IEC 1672, i.e. a self-contained battery-operated instrument that requires no external connections to other apparatus to measure sound levels.

Basic Configuration

The Mediator comprises the following:

- 2238 Mediator Integrating Sound Level Meter
- Basic SLM Software BZ 7126
- Microphone Preamplifier ZC 0030
- Prepolarized free-field 1/2" Condenser Microphone Type 4188
- 9-pole cable with 25-pole Adaptor AO 1386 (null-modem cable for serial interface)
- Shoulder Bag KE 0323
- Protective Cover UA 1236
- 4×Alkaline Batteries QB 0013

1.2.1 How Mediator Works

The Mediator can be configured to a wide range of requirements with different software packages or a combination of these packages. You can easily upgrade the software via the serial RS-232 interface or it can be performed at a Brüel & Kjær service centre. The Frequency Analysis Software option requires Type 2238-A-F (with filter set) or a hardware upgrade (installation of filter set 2238 MUF), that

must be made at a Brüel & Kjær service centre. If the Mediator is ordered with Frequency Analysis Software BZ 7123, the filter set is part of the instrument.

Refer to the block diagram in Fig.1.1 for an overview of how the Mediator works. The signal from the microphone is fed through the appropriate amplifiers, the desired filters (“A”, “C”, “L” or octave filters (if fitted)) and correction filters (“Sound Incidence”, “Windscreen”). The multiplexer switches two signals (either the same signal or with different weightings) through to the RMS and the RMS/Peak detectors and succeeding Time Weighting filters. At this point the signals are still in the analogue domain. The signals are now converted in the D/A-converter and all subsequent signal processing is in the digital domain. Finally the signals are fed through the D/A-converter and the buffered signals are output to the **Aux 1** and **Aux 2** connectors via the multiplexer.

Detectors

One of the main features of the Mediator is that it contains two detectors with independent frequency weighting functions. In the basic package, one is an RMS detector and the other a Peak detector. Linear and A- and C-weighting can be selected for both detectors. F (Fast), S (Slow) and I (Impulse) time weighting must be selected in the basic version. Both frequency and time weightings must be selected before a measurement is performed.

1.2.2 Application Programs

The following software modules are available for upgrading the Mediator:

- Frequency Analysis Software BZ 7123 — general purpose module for scanning $1/1$ - and $1/3$ -octave bands. BZ 7123 requires the $1/1$ -octave and $1/3$ -octave filter set (2238 MUF). If the Filter Set has already been installed, you can order BZ 7123 alone. Refer to ordering information in the associated Product Data sheet.
- Logging SLM Software BZ 7124 — allows a large range of parameters to be logged. This module allows logging

Chapter 1 – Introduction

About the 2238 Mediator

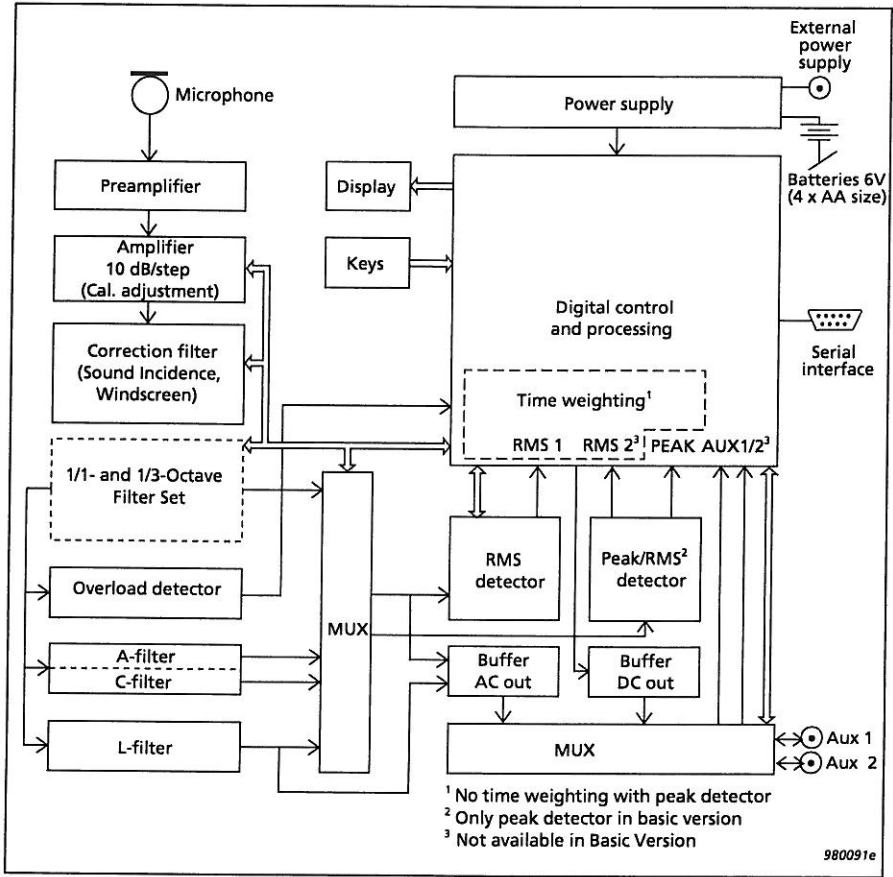

Fig. 1.1 Simplified block diagram for 2238 Mediator

of all relevant parameters from Enhanced SLM Software BZ 7125.

- Enhanced SLM Software BZ 7125 — adds a number of powerful features to the basic version. Including: statistics, back-erase function and the possibility of two simultaneous RMS measurements.

Filter Set

The $1/1$ -octave and $1/3$ -octave filter set is required with the frequency analysis module, but the filter set can be installed and used with all modules. In this case the filter bands are available as a frequency weighting that can be selected manually.

Changing Application

Push the \square key to display the System menu from which you can select the desired application module. Refer to section 4.1 in Chapter 3 for more details about the System menu.

1.3 Measurement Parameters

Table 1.1 lists the discrete parameters available with the Basic package. The X and Y suffixes in the parameter names refer respectively to frequency weightings (A, C or L) and time weightings (S, F or I).

You can change the displayed parameters during measurement or in pause mode. Press the ∇ key to enter set-up mode and use the ∇ and \blacktriangle keys to select (highlight) the desired parameter in the Measurement Window. Use the \blacktriangleleft or \blacktriangleright keys to change the parameter. When you have set up the desired parameters, exit the set-up mode by going to the top or the bottom of the window with the ∇ or \blacktriangle keys.

Chapter 1 – Introduction
Measurement Parameters

Detector 1 — RMS Parameters				
Parameter	Default screen parameter	Definition	Freq. Weighting	Time Weighting
L_{Xeq}	LA_{eq}	Equivalent continuous level for the duration of the measurement as defined by IEC 1672	"A", "C" or "L"	–
L_{XYav4}	LA_{Fav4}	Averaged sound level with an Exchange Rate of 4 dB (L_{DOD})	"A", "C" or "L"	"F" or "S"
L_{XYav5}	LA_{Fav5}	Averaged sound level with an Exchange Rate of 5 dB (L_{OSHA})	"A", "C" or "L"	"F" or "S"
L_{XE}	LA_E	Frequency weighted sound exposure level for the duration of the measurement as defined by IEC 1672 (SEL, 1 s)	"A"	–
$L_{Xep,d}$	$LA_{Fep,d}$	Daily Personal Noise Exposure. Recommended by EEC Directive EEC/86/188	"A"	–
E_A	EA, d	Total sound exposure for the duration of the measurement in Pa^2h	–	–
L_{Xyp}	LA_{Fp}	Sound pressure level (SPL)	"A", "C" or "L"	"F", "S" or "I"
L_{XYmax}	LA_{Fmax}	Max. L_{Xyp} value detected within the elapsed time	"A", "C" or "L"	"F", "S" or "I"
L_{XYmin}	LA_{Fmin}	Min. L_{Xyp} value detected within the elapsed time	"A", "C" or "L"	"F", "S" or "I"
L_{XYinst}	LA_{Finst}	Randomly sampled instantaneous value of RMS level	"A", "C" or "L"	"F", "S" or "I"

Table 1.1 Parameters available with the Basic package

Detector 2 — Peak Parameters				
L_{Xpk}	LCpk	Instantaneous peak level	"C" or "Lin."	–
L_{Xpkmax}	LCpkmax	Max. Peak level detected during the measurement	"C" or "Lin."	–
General – other parameters				
Number of Peaks	#cPeaks	Counts the number of seconds where a specified peak level is exceeded during a measurement	"C" or "Lin."	–
Dose% _X	ADose	The dose percentage based on the $L_{X_{eq}}$ (3 dB exchange rate)	"A"	"F" or "S"
Dose% _{XY4}	AFDose4	The dose percentage based on the L_{av} and a 4 dB exchange rate	"A"	"F" or "S"
Dose% _{XY5}	AFDose5	The dose percentage based on the L_{av} and a 5 dB exchange rate	"A"	"F" or "S"
Overload%	Over-load%	The percentage of time that an overload occurred during a measurement	–	–
Under-range%	Under-range%	The percentage of time that an under-range occurred during a measurement	–	–
Elapsed Time	Elapsed Time	The amount of time that has passed since the current measurement began (measurement time excluding pauses)	–	–
Start Time	Start Time	The start time for the current measurement	–	–





Table 1.1 (Cont.) Parameters available with the Basic package

Start Date	Start Date	The start date for the current measurement	–	–
Time	Time	The current time	–	–

Table 1.1 (Cont.) Parameters available with the Basic package





1.4 Menu Structure

Mediator has four main menu modes, each initiated by a dedicated hard key:





-  System menu. section 1.4.2
-  Measurement Set-up menu. See section 1.4.3 below
-  Calibration menu. See section 5.1
-  Data Files. See section 1.4.5 below

The Mediator must be in pause mode before you can select one of these menus.

1.4.1 Navigation

Press the desired main menu hard key (see above) when the normal Measurement Window is displayed. Use the  and  keys to step through the available Settings. The selected Setting is indicated as inverse text. Press the  soft key  if you want to go to another menu.

Note: You must always revert to the Measurement Window before you can change menu.

When you reach a Setting you want to change, press the  soft key  or the  cursor key. The set-up options for that setting are displayed. The first set-up line you can change is indicated as inverse text. If there are other set-up lines on the screen you can select them with the  and  keys.

Use the ◀ and ▶ keys to change the parameter you want to change. Press the <Save> soft key to save the new parameter setting. If you change a parameter by mistake, press the <Cancel> soft key □ or the 📏 Meas. Results key to revert to the previous setting. The <Cancel> soft key □ steps one level up, the 📏 Meas. Results key reverts to the Measurement Window.

If you press a key that is not allowed or irrelevant in the current set-up, the ✕ Illegal Entry symbol will appear for a second in the upper right hand corner of the display.

1.4.2 System Menu

Pushing the 📏 key will display the System menu. For more information about setting up basic system parameters, see Chapter 3.

For selecting/setting up:

- Application (for selecting software module)
- Date & Time (for setting the date and time)
- Serial Interface (for setting up the serial interface parameters)
- Printer Interface (for setting up the printer interface parameters)
- Language (for selecting the user interface language)
- Display (for setting the display contrast)
- Standards (lists the standards that the Mediator complies with. Also shows the installed software modules)
- About (system information)

1.4.3 Measurement Set-up Menu

Pushing the 📏 key will display the Measurement Set-up menu. For more information about setting up the Mediator for measurement, see Chapter 4.

The following Settings are available:

- General (for setting the measurement range, the Peaks Over level and the second exchange rate)
- Weightings (for setting the frequency weightings for Detector 1 and 2)
- Measurement Control (for setting up an Auto Start measurement)
- Correction Filters (for selecting correction filters for sound incidence and windscreen)
- Input/Output (for setting up the **Aux 1** and **Aux 2** sockets)
- Auto Start (for selecting an Auto Start)
- Occupational Health (for setting up the Occupational Health parameters)
- Save Setup (for saving a measurement set-up)
- Recall Setup (for recalling a measurement set-up)

Note: You can also change the measurement range by pressing the  key.

1.4.4 Calibration Menu

Pushing the  key will display the Calibration menu. Refer to Chapter 4 for more information.

- Calibration (for calibrating the Mediator)
- Calibration History (contains information about the initial calibration and the 20 latest calibrations)

1.4.5 File System

Memory

Data files, measurement settings, calibration data and calendar data (date and time) are all saved in RAM. This memory is maintained when you turn off the instrument. If the

batteries are removed, the back-up battery will retain the memory for minimum 6 months (if charged), so that data is saved.

The serial number and some internal calibration factors are stored in Flash RAM, which is a non-volatile memory.

Buffer

Holds all of the measurement results from the last measurement period. The buffer is updated once a second. It is cleared each time you start a measurement with the \rightarrow key. Results in the buffer can be output to a printer or saved in a file.

Data Files

Measurements are saved in Mediator as files with a file number and an extension. In addition the files can be identified by the date and time when the file was saved.

You can normally store up to 500 files for each software package. However, the number of files may be reduced if a large amount of data is occupied by the Logging module. A warning is displayed if there is not sufficient memory for the current measurement.

All files are preserved when you turn off the instrument, except for the data in the buffer. All measurement data are copied from the buffer. Measurements can be stored automatically (measurements with a preset measurement time) or manually (at any time after a measurement is paused).

A basic measurement data file consists of a group of set-up data and a group of associated measurement data. The set-up data are:

- Serial number for the Mediator
- Initial calibration parameters
- Calibration set-up
- Measurement set-up

Measurement data are:

- Set-up and Calibration data
- Broadband RMS data
- Broadband Peak data

For more information about Data Files, see Chapter 5.

1.5 Backlight

The backlight makes the display easier to read in low light situations. Press  to turn it on or off. To save batteries, the light will switch off automatically after 30 seconds.

Chapter 2

Getting Started

2.1	Getting Started.....	2-2
2.2	Fitting Batteries	2-2
	Checking the Battery Level	2-2
	Using an External Power Supply	2-4
	The Back-up Battery	2-4
	Switching the Mediator On and Off	2-5
	Dismantling/Mounting the Microphone	2-5
2.3	Pushkey Definitions	2-8
2.4	Measurement Window	2-10
2.5	Changing the Language	2-12

2.1 Getting Started

As supplied from the factory, the Mediator is fitted complete with microphone and input stage. You only need to fit the batteries before the instrument is ready for measuring

2.2 Fitting Batteries

Fitting Batteries for the First Time:

1. The battery compartment is located in the centre of the back of the instrument. Press the two tabs on the upper edge of the battery compartment and remove the lid.
2. Insert new batteries (four 1.5V LR6/AA size alkaline batteries) following the +/- orientation shown in the bottom of the battery compartment.
3. Press the compartment lid back into place.

Note: If you cannot switch on the Mediator after inserting the batteries, check that you have inserted them correctly. The Mediator will not switch on if the batteries are inserted incorrectly, however, it will not be damaged.

2.2.1 Checking the Battery Level

The battery symbol  in the upper right hand corner of the Measurement Window indicates the current battery level. When the battery is full, the battery level indicator is fully black. As the batteries are used, the level will fall until the indicator is completely empty. When it is time to replace the batteries, the indicator will be empty and blinking.

The battery level indicator has five indication lines in it. Each line represents approximately 20% of remaining battery time (at room temperature), see Fig. 2.1. When the indicator is empty and blinking, there is less than 15 minutes left. Under

extreme cold or hot environments, the remaining time may be less.

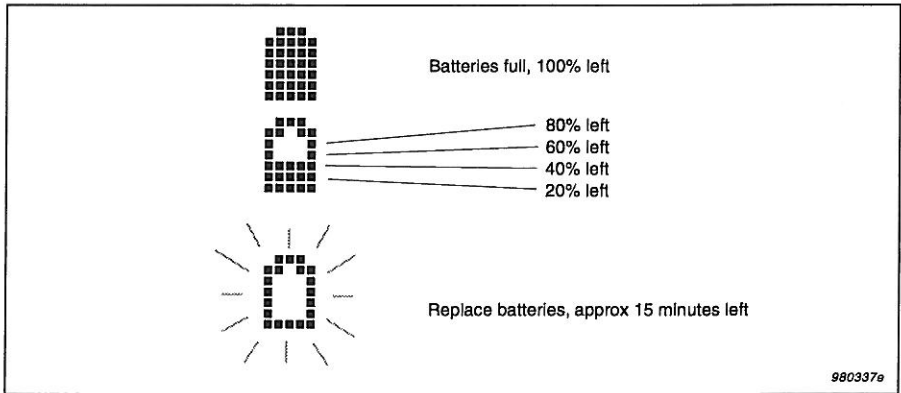

Fig.2.1 Interpreting the battery level indicator

Caution

It is possible for batteries to explode or leak if they are handled incorrectly, so:

- For long-term storage, remove the batteries and keep the sound level meter in a dry place.

Note: For very long-term storage (more than 6 month) you must save the files and settings on a PC, if required. See section 2.2.3.

- Never mix different makes or types of battery.
- Never mix new and old batteries.

Note: Rechargeable batteries can be used, however, the operating time may vary considerably, depending on the type and condition of the cells. The batteries will not be charged when using an external power supply for the Mediator, they must be charged outside the instrument.

2.2.2 Using an External Power Supply

The sound level meter can be powered from a regulated 7 – 15 V DC supply via the External Power socket on the base (e.g. from a mains supply adaptor, see ordering information in Product Data). The power supply must be able to supply minimum 400 mA in the nominal voltage range. Maximum allowable ripple from the adaptor is $100 \text{ mV}_{\text{peak-peak}}$.

You can connect the external power supply even when the batteries are installed. The sound level meter automatically selects the source with the highest supply voltage. The external power supply will not damage the batteries and it will not charge rechargeable batteries.

Note: It is recommended that batteries are always fitted when using an external power supply. This prevents loss of power if the external supply is accidentally disconnected.

2.2.3 The Back-up Battery

The sound level meter has a back-up battery for running the clock and maintaining the data files, even when it is switched off or the main batteries are removed. Other data, including the serial number, the microphone serial number and calibration data, are stored in Flash RAM and will remain irrespective of the back-up battery. If the back-up battery is flat, a “Preparing file system” message will appear when the instrument is switched on and files in the memory are lost.

The back-up battery is recharged automatically when there are standard batteries in the sound level meter. It is fully charged after about 10 hours. Fully charged, the back-up battery runs the clock and retains records and settings for about 6 months. These charge times are typical for a sound level meter at room temperature.

2.2.4 Switching the Mediator On and Off

Switching On

Press $\text{\textcircled{1}}$. The Brüel & Kjær logo is displayed for a few seconds before the Measurement Window appears. The instrument returns to pause mode with the set-up it had when it was last switched off.

Default Set-up

You can revert to the default set-up by recalling Default from the Save/Recall Window in the Measurement Set-up menu, see section 4.1.11. All results in the buffer are deleted and the instrument returns to the default set-up in pause mode. Refer to section 10.2 in Appendix 1 for a list of default parameters.

Switching Off

The Mediator can only be switched off from pause mode. Press $\text{\textcircled{2}}$ to enter pause mode and then press $\text{\textcircled{1}}$ to switch off the instrument. Even when the instrument is switched off, the memory circuits are still energized and all settings and saved measurement data are maintained.

2.2.5 Dismantling/Mounting the Microphone

If it is required to dismantle/mount the microphone, note the following precautions:

- When screwing on the microphone, input stage, protection grid and extension cables, **do it gently** to avoid damaging the threads.
- Keep dust and foreign matter off the microphone diaphragm. Do not touch the diaphragm with anything — it is very delicate. Small amounts of dust on the diaphragm will not affect the microphone response.

Dismantling/Mounting the Microphone and Input Stage

The microphone supplied with the Mediator is the Prepolarized Free-field $\frac{1}{2}$ " Microphone Type 4188 that requires no external polarization voltage.

1. Unscrew the threaded retaining ring (see Fig. 2.2) that secures the input stage. The input stage can now be removed from the input stage socket at the top of the Mediator.

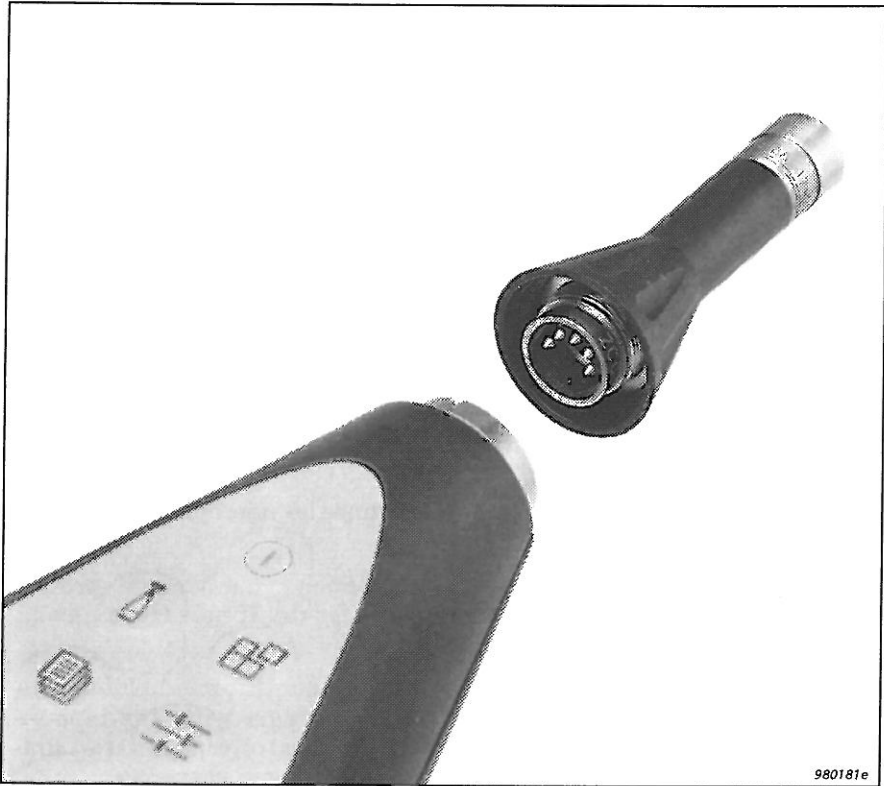

Fig.2.2 Mounting the input stage and microphone onto the sound level meter. 5-pin DIN connectors are used

2. Unscrew the microphone from the Input Stage ZC0030.
Do not remove the protection grid from the microphone.

Fitting is the reverse of dismantling.

Connecting a Microphone Extension Cable

Two optionally available extension cables can be used with the Mediator:

- AO 0561 3 m long
- AO 0560 10 m long

Note: Older cables Types AO 0408 and AO 0409 can also be used.

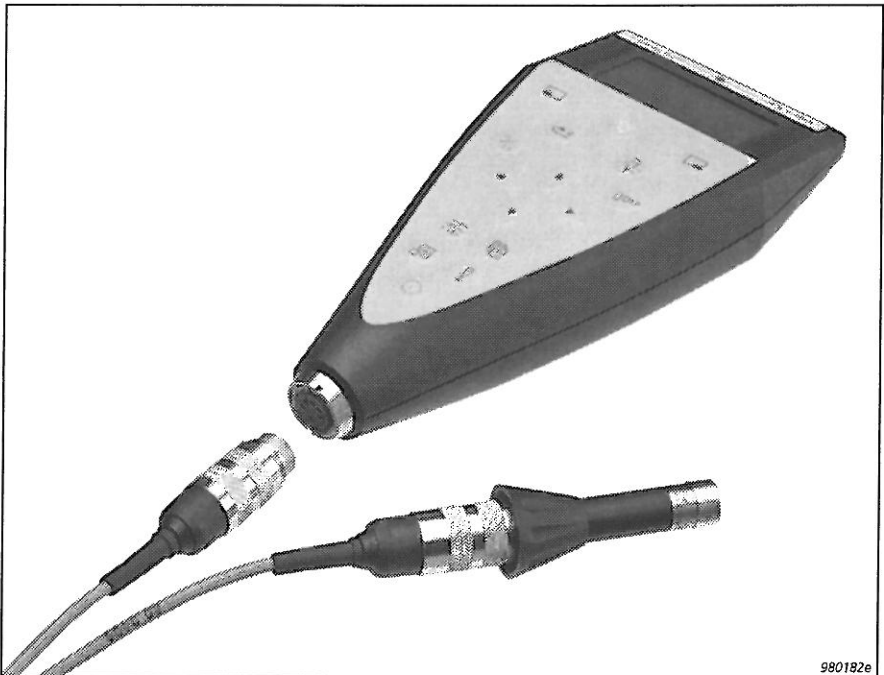

Fig.2.3 Connecting a microphone extension cable to the sound level meter





To Connect:





1. Insert the microphone extension cable into the input stage. Secure the connection by turning the threaded retaining ring.
2. Insert the other end of the microphone extension cable into the input stage socket and secure by turning the threaded retaining ring. (see Fig. 2.3).





Note: Connecting a recommended microphone extension cable has no effect on the sound level meter's calibration. Therefore, you do not have to re-calibrate after connecting one of the recommended microphone extension cables.

2.3 Pushkey Definitions

Each pushkey on the sound level meter's front panel is marked with a pictogram. This section gives a brief explanation of the buttons.

Power		Press this key to switch the instrument on or off. The instrument will be in pause mode when started up.
Calibrate		Press this key to calibrate your instrument. See section 5.1 for calibration instructions.
System		Press this key to display the System menu for configuring the instrument and for changing application programs. See section 4.1 in Chapter 3 for system options.
Data Files		Press this key to select the Data Files menu. The menu options in this window allows you to save, print and edit printout files and to access the File Manager facility.

Set-up		Press this key to access/step through the set-up options in the Measurement Set-up menu. See section 4.1.2 in Chapter 3 for details about the available settings.
Up/Down Arrows ▲ ▼		Press these keys to step up/down in the menu items in the selected window. Also for entering/exiting edit mode in the Measurement Window.
Left/Right Arrows ◀ ▶		Press these keys to select the parameters in the selected window. Note: For the sake of consistency the ▲ ▼ keys are always used to select menu items, and the ◀ ▶ keys are always used to select values.
Range		Press this key to access the Range Setting menu. Use the ◀ ▶ keys to step through the available measurement ranges or scroll with the  key.
Reset		Resets the current measurement data and sets the buffer and timer to zero. If a measurement is in progress, it will continue immediately after reset. If the instrument is paused, it will still be paused after pressing Reset. Note: If a measurement has been in progress for more than a minute a warning is displayed and you must confirm the command before any data is deleted.
Meas. Results		Press this key in any of the set-up menus to return to the Measure-

Pause/Continue		Press this key to pause/continue the current measurement. If the sound level meter is in pause mode, the measurement is continued without resetting data or the timer.
Select		Softkey with functions <Select>, <Save>, <Recall> or <Ok> depending on the cursor position in the current menu. The <Menu> function displays the File Manager Options Window.
Cancel		Softkey with functions <Cancel>, <Undo> or <Close> depending on the cursor position in the current menu.
Backlight		Switches the display's backlight on or off. To save batteries, the backlight switches off automatically after 30 seconds.

2.4 Measurement Window

During normal operation the Measurement Window is used to view the measured data. It provides several kinds of information about your settings and measurements.

1. *Bar graph*: This is a quasi-analogue display that shows a graphical representation of the current sound pressure level (Inst.), based on the RMS value from Detector 1. It is updated 5 times a second.
 - a. *The bottom end of the measurement range (in dB)*: All sound below this level will register as under-range. To change the starting point for the measurement range,

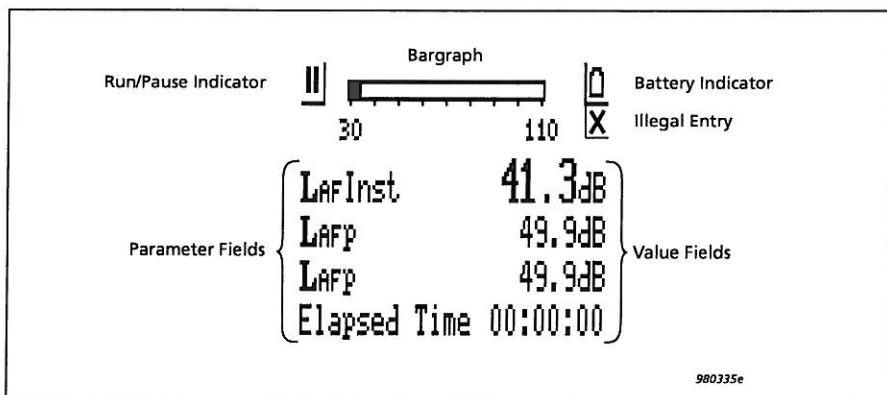

Fig. 2.4 The Measurement Window

press while measurement is paused, you can then step up the measurement range.

- b. *The upper end of the measurement range (in dB) and overload indicator:* Peaks above this level will trigger an “OVERLOAD” indication that will appear under the bar graph, see Fig. 2.5. If an overload has occurred in the last one second, this indication will stay for the next second. This indication will appear both in pause mode and in measurement mode. If an overload occurs during a measurement in progress, a “latched overload” symbol will appear to the right of the bar graph, see Fig. 2.5. The latched overload remains until the measurement is reset, also if the measurement is paused. To change the measurement range, press .

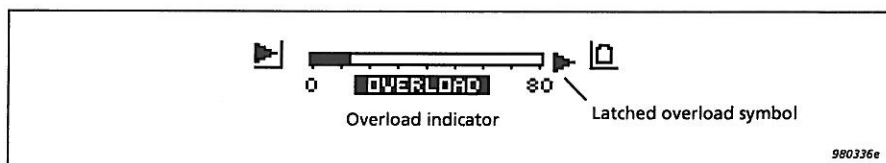

Fig. 2.5 Overload indicators

2. *Run/Pause indicator*: Displays the current status of measurement. Press $\frac{1}{2}$ to continue ► or pause || a measurement. Press \rightarrow to start a “new” measurement (resetting measurement data and the timer).
3. *Battery level*: When the batteries are new, the ■ indicator is completely black. As the batteries are used, the level falls. Replace the batteries when this indicator is empty and blinking.
4. *Parameter fields*: Specifies the measurement parameters
5. *Value fields*: Indicates the measurement values for the selected parameters.
6. *Illegal Entry*: The ✕ symbol lights up for a second if you press a key that has no function in the current window.



2.5 Changing the Language

The default user interface language for the Mediator is English.

How to Change the Language

The following languages can be selected

- English
 - Français
 - Deutsch
 - Italiano
 - Español
1. From the Measurement Window press the \square hard key to select the System menu.
 2. Select the Language menu item with the ▲ ▼ cursor keys and enter by pressing the \square <Select> softkey.

3. Select the language you want to install by using the ◀ or ▶ keys.
4. When the desired language is displayed, press the  <Save> softkey to enter the selection.
5. Press the  <Cancel> softkey twice to return to the Measurement Window, or press the  Meas. Results key.

Chapter 3

System Menu

3.1	System Menu.....	3-2
	Introduction	3-2
	Selecting the System Menu and Parameters.....	3-2
	Selecting Application Module	3-4
	Setting the Date and Time.....	3-4
	Setting up the Serial Interface Parameters.....	3-5
	Setting up the Printer Interface Parameters.....	3-6
	Choosing the Language.....	3-7
	Adjusting the Display Contrast.....	3-7
	Displaying the International Standards	3-8
	Displaying System Information.....	3-8

3.1 System Menu

3.1.1 Introduction

This chapter explains how to set up basic parameters in the System menu, such as application program, interface and language. Once these parameters are set up, they are not normally changed until a measurement session is completed.

3.1.2 Selecting the System Menu and Parameters

The System menu is used for setting up and reading basic system parameters. It contains the menu items shown in Fig. 3.1.

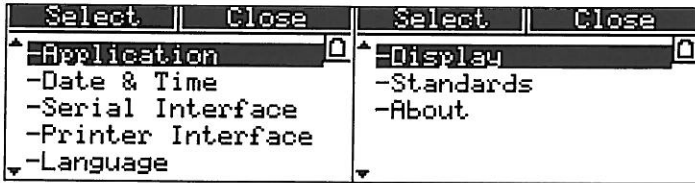





Fig. 3.1 The System menu. The arrows to the left indicate that there is more than one window

1. The System menu is accessed by pressing the  System key when the instrument is paused. If the instrument is measuring you must press  to pause. Select the desired menu item with the ▲ ▼ cursor keys.

This will also cause the <Select> and <Close> soft keys to appear.

2. Press the  <Select> softkey or the ► cursor key to enter the selection.

This will also cause the <Ok> and <Cancel> soft keys to appear.

Alternatively you can step through the menu items by pressing the System key repeatedly. The first time you press the key the System menu is displayed and the following key clicks steps you directly through the menu items, starting with the first item in the menu.

The arrows on the left-hand side of some of the screens indicate that there is more than one screen page. These pages are cyclic, i.e., when you pass the top or the bottom line of the menu you automatically go the bottom or top line of the next/previous page, respectively.

Selecting Parameters

1. Select the desired parameter from the sub-menu with the ▲ ▼ cursor keys.
2. Then use the ◀ ▶ cursor keys to step through the available settings or values of that parameter until the one you need is displayed.

The range of available settings for each parameter is given in the following sections.

Note: If you want to change a parameter value, you may hold the ◀ ▶ cursor keys down to automatically increase or decrease the value.

3. Press the <Ok> soft key to confirm the selection. If you wish to undo any of these, press the <Cancel> soft key and all settings/values will revert to what they were the last time the <Select> soft key was pressed.
4. Repeat steps 1, 2 and 3 until you are satisfied with the setting or value of each parameter.
5. Press the <Close> softkey to revert to the Measurement Window after you have pressed the <Ok> or <Cancel> key.

Note: Normally you can use the  Meas. Result key to go directly from a menu to the Measurement Window.

3.1.3 Selecting Application Module

Select the desired application module from the Application Window. You can only select the application modules that have been installed in the instrument. Refer to the associated User Manuals for installation of application modules.

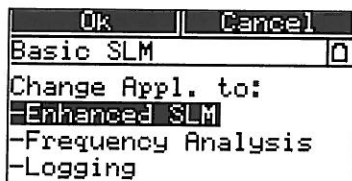

Fig.3.2 The Application Window. This example contains three application modules (the Basic SLM Software is always installed)

The currently possible options are:

- Enhanced SLM — Enhanced SLM Software BZ7125
- Freq. Anal. SLM — Frequency Analysis Software BZ7123
- Logging SLM — Logging SLM Software BZ7124

3.1.4 Setting the Date and Time

The Date & Time Window has the appearance as shown in Fig. 3.3.



Fig.3.3 The Date & Time Window

You can set:

- Year
- Month
- Date
- Time

The clock is running while you set the date and time. Simply step the clock settings forwards or backwards until the clock is synchronized with the real time.

3.1.5 Setting up the Serial Interface Parameters

The Baud Rate and Handshake interface parameters can be set up from the Serial Interface Window illustrated in Fig. 3.4. Notice that these parameters are used only for control via the RS 232 interface.

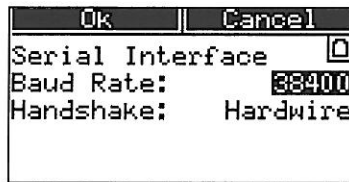

Fig. 3.4 The Serial Interface Window

You must set up the interfaces of the Mediator and the instrument connected to the serial interface socket to the same baud rate and handshake settings to enable communication.

Setting the Baud Rate

- 4800
- 9600
- 19200
- 38400
- 115200

Select the desired baud rate in the Baud Rate field.

Selecting Handshake

- Hardwired
- Modem

Select the desired type of handshake in the Handshake field.

3.1.6 Setting up the Printer Interface Parameters

You can set up separate Baud Rate and Handshake interface parameters for a printer, in the Printer Interface Window illustrated in Fig. 3.5.

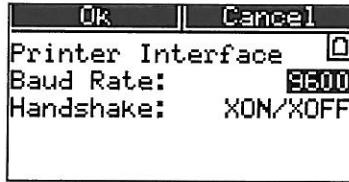

Fig. 3.5 The Printer Interface Window

Setting the Baud Rate

- 4800
- 9600
- 19200
- 38400
- 115200

Select the desired baud rate in the Baud Rate field.

Selecting Handshake

- XON/XOFF
- Hardwired

Select the desired type of handshake in the Handshake field.

3.1.7 Choosing the Language

The language used in the instrument's display screen can be changed in the Language Window, as illustrated in Fig. 3.6.

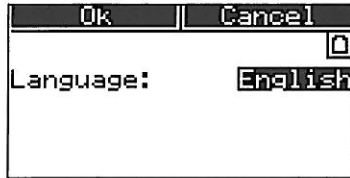

Fig. 3.6 The Language Window

The following languages can be selected

- English
- Deutsch
- Espanol
- Francais
- Italiano

3.1.8 Adjusting the Display Contrast

You can adjust the LCD screens contrast in the Display Window (see Fig. 3.7), to compensate for various lighting conditions and viewing angles. The contrast adjustment is particularly useful in very high or low temperature environments.



Fig. 3.7 The Display Window

Contrast Adjust

- 1 - 5

You can adjust the contrast in five steps, where 5 indicates the highest contrast level. The default setting is 3.

3.1.9 Displaying the International Standards

The Standards Window in Fig.3.8 shows the international standards that Mediator complies with.

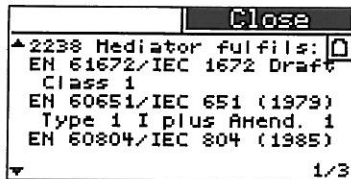

Fig.3.8 The Standards Window

3.1.10 Displaying System Information

The About System Window is shown in Fig. 3.9 and contains the following information:

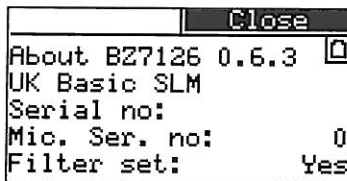

Fig.3.9 The About System Window

- Current application module (type)
- Mediator serial number
- Microphone serial number (supplied microphone)
- Filter set

Chapter 4

Measurement Set-up Menu

4.1	Measurement Set-up Menu	4-2
	Introduction	4-2
	Selecting the Measurement Set-up Menu and Parameters	4-2
	Setting up General Measurement Parameters	4-3
	Setting Frequency Weightings	4-5
	Measurement Control	4-6
	Selecting Correction Filters	4-7
	Setting up the Input/Output Function	4-8
	Setting Mediator to Start Automatically	4-9
	Setting the Occupational Health Parameters.....	4-11
	Saving Measurement Set-ups	4-12
	Recalling Measurement Set-ups.....	4-13

4.1 Measurement Set-up Menu

4.1.1 Introduction

This chapter explains how to set up basic measurement parameters in the Measurement Set-up menu, such as range and weighting.

4.1.2 Selecting the Measurement Set-up Menu and Parameters

The Measurement Set-up menu is used for setting up basic measurement parameters and measurement control parameters. Basic SLM Software BZ 7126 contains the menu items shown in Fig. 4.1.

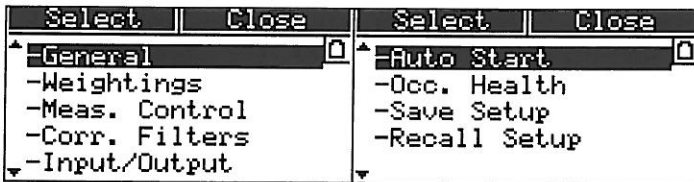

Fig. 4.1 The Measurement Set-up menu (two windows)

1. The Set-up menu is accessed by pressing the \equiv System key when the instrument is paused. If the instrument is measuring you must press ⏏ to pause. Select the desired menu item with the \blacktriangle \blacktriangledown cursor keys.

This will also cause the <Select> and <Close> soft keys to appear.

2. Press the \square <Select> softkey or the \blacktriangleright cursor key to enter the selection.

This will also cause the <Ok> and <Cancel> soft keys to appear.

Alternatively you can step through the menu items by pressing the Set-up key repeatedly. The first time you press the key the Set-up menu is displayed and the following key clicks steps you directly through the menu items, starting with the first item in the menu.

The arrows on the left-hand side of some of the screen indicate that there is more than one screen page. These pages are cyclic, i.e., when you pass the top or the bottom line of the menu you automatically go the bottom or top line of the next/previous page, respectively.

4.1.3 Setting up General Measurement Parameters

The General Window is used for setting up the measurement range, the peaks over indication and the second exchange rate, see Fig. 4.2.

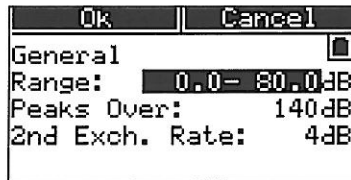

Fig. 4.2 The General Window

Measurement Range

In Range you can select the following default measurement ranges:

- 0 to 80 dB
- 10 to 90 dB
- 20 to 100 dB
- 30 to 110 dB
- 40 to 120 dB
- 50 to 130 dB
- 60 to 140 dB

Note that the dynamic range is always 80 dB. However, if a non-standard transducer is used and calibrated, the upper and lower limits may be offset.

The range you choose will depend on the environment in which you are measuring. It is important to select the measurement range so that the instrument is sensitive enough to measure all relevant sound, but not so sensitive that it overloads. Your measurement will not be accurate if an overload occurs. See section 2.4 for more information about overloads.

To Set the Measurement Range

Check the current measurement range. It is shown at the top of the Measurement Window.



Use the quasi-analogue display to decide if you have set the range correctly. If the display is blank most of the time, then sound levels are too low; select a lower measurement range. If the display becomes full and the “Overload” warning appears under the bar graph, then sound levels are overloading the instrument; select a higher range.

Alternatively you can access the Range Setting Window directly by using the  key.

Setting the Peaks Over Indication

Peaks Over fixes a level for counting the number of times this level is exceeded by peak values and registered during a measurement. Intervals of 1 s are used and only one overload per period is registered.

The Peaks Over level can be set in 1 dB steps from 0 to 180 dB. The setting is independent of the selected linear measurement range (see above). The default level is 140 dB.

Note that the first decimal(s) and the last decimal of the value field are set up independently. Use the   cursor keys to select the desired decimal.

To monitor the Peaks Over value on the screen, select the #cPeaks field in the Measurement Window.

Setting the Second Exchange Rate

The 2nd Exch. Rate is used for evaluation of hearing risk and is described in Appendix section 10.1.

The 3 dB Exchange Rate is always measured. You can select an additional Exchange Rate of 4 or 5 (dB). The Second Exchange Rate is used for measuring averaged sound levels with 4 dB (L_{DOD}) or 5 dB (L_{OSHA}) Exchange Rate, respectively. The $L_{X_{av}}$ parameter will change accordingly in the Measurement Window.

4.1.4 Setting Frequency and Time Weightings

The Weightings Window is used for setting up time and frequency weightings for detector 1 and frequency weightings for detector 2, see Fig. 4.3.

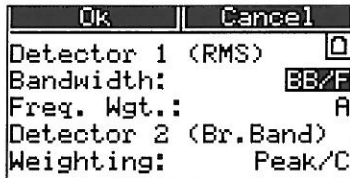

Fig. 4.3 The Weightings Window

In the basic version, Detector 1 is RMS and Detector 2 is Peak.

Setting Bandwidth and Time Weighting for Detector 1 (RMS)

- Broad-band (F, S, I)
- 1/3-octave (F, S, I)
- 1/1-octave (F, S, I)

Select the desired option in the Bandwidth field.

Note: The 1/3-octave and 1/1-octave options only appears when the 1/1-octave and 1/3-octave Filter Set is installed in Mediator.

Setting Frequency Weighting for Detector 1

- A, C, L (Broad-band)
- 31.5 Hz ... 8 kHz (1/1-octave)

- 20 Hz ... 12.5 kHz (1/3-octave)

Select the desired standardized frequency weighting or centre frequency in the Freq. Wgt. field. The centre frequencies depend on the setting in the Bandwidth field.

Setting Frequency Weighting for Detector 2 (Broad-band)

- Peak/C
- Peak/L

You can select the C or L frequency weighting for Detector 2 in the Weighting field.

4.1.5 Measurement Control

The Meas. Control Window is used to set up a preset measurement time and to activate/deactivate it, see Fig. 4.4.

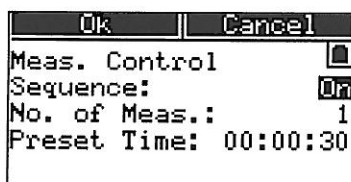

Fig. 4.4 The Measurement Control Window

In the Basic module only one measurement can be specified in the No. of Meas. field (in the Enhanced module you can specify up to 99 measurements).

When switched On, the Auto Start is started as a normal measurement, using the $\frac{1}{2}$ key. During an Auto Start you can control the instrument in the normal way, for example, you can pause a measurement and resume it.

Switching the Sequence On/Off

The Sequence field is for switching the measurement sequence On or Off. The sequence parameters only appears when sequence is set to On.

Setting the Preset Measurement Time

Preset Time is for pre-setting the measurement time.

- **Hours:** Can be set from 0 to 99 in one hour steps
- **Minutes:** Can be set from 0 to 59 in one minute steps
- **Seconds:** Can be set from 0 to 59 in one second steps

Note: Minimum measurement time is 30 seconds

4.1.6 Selecting Correction Filters

The Correc. Filters Window in Fig. 4.5 allows you to select filters to make corrections for sound incidence and windscreen influence.



Fig. 4.5 The Correction Filters Window

Selecting the Sound Incidence Filter

The Sound Incidence correction can be set to:

- Frontal
- Random

In general Frontal is used for sound with 0° incidence and Random is used for diffuse sound. In practice the correction depends on your local standard and the application. Generally ISO requires Frontal and ANSI requires Random.

Selecting the Windscreen Correction

The Windscreen Correction can be set to:

- On
- Off

The windscreen filter makes a frequency correction corresponding to the influence of Windscreen UA0237. With the correction on, Class 1 precision is maintained over the full frequency range (see specifications).

4.1.7 Setting up the Input/Output Function

The Input/Output Window controls the function of the **Aux 1** and **Aux 2** inputs/outputs. See Fig. 4.6.

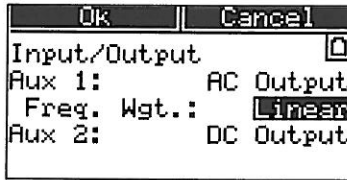

Fig. 4.6 The Input/Output Window

In the Basic module **Aux 1** is always set to AC output and **Aux 2** is always set to DC output.

Selecting Frequency Weighting for Aux 1

In the Freq. Wgt. field you can select:

- Linear
- Det. 1

AC Output supplies the AC output signal to the **Aux 1** socket. Frequency weighting depends on the Freq. Wgt. field (see below). Full-scale indication corresponds to 1 VRMS and the output is attenuated according to the selected range. This output signal can be used, for example, for recording the measured signal on a DAT recorder.

L frequency weighting is used when Linear is selected. When you select Det. 1, the frequency weighting selected on the RMS detector is used.

Aux 2

DC Out supplies a DC output signal equivalent to the AC output signal. It is the time weighted signal (Fast, Inst.) from detector 1. Full-scale indication corresponds to 4.0 VDC (50 mV/dB).

4.1.8 Setting Mediator to Start Automatically

The Auto Start Window allows you to set up Mediator to start automatically at any time and date within the next month. The Auto Start Window is illustrated in Fig. 4.7.

Ok	Cancel
Auto Start no.:	1 <input type="checkbox"/>
Application:	827125
Date:	1998 Jul 08
Time:	17:06:35
Use Setup no.:	1

Fig. 4.7 The Auto Start Window

After setting up an Auto Start the Mediator must be switched off. Then, at the set time, it will switch on, load the specified set-up, reset and start measuring.

Once the Mediator has started measuring with Auto Start, you can control it in the normal way. Measurements will continue until the Mediator is switched off manually or the batteries run out.

If the Mediator is already switched on at the time it has been set to automatically start measuring, Auto Start is cancelled and has no effect. Auto Start does not affect your use of the Mediator while it is switched on or your current measurement results.

When the set Auto Start time has passed, Auto Start will be switched off when you switch off the instrument. This prevents the instrument from repeating an automatic measurement every month.

Selecting an Auto Start

In the Auto Start no. field you can set up up to four different Auto Starts. You must ensure that there are no conflicts with other Auto Starts. If two Auto Starts in different applications are set up to start within the same time span, the Auto Start that starts first takes priority.

Application

The Application field shows the name of the application module from which the current Auto Start was created. The following options exist:

- None

Disables the current Auto Start and indicates that this Auto Start has not been set up.

- BZ xxxx

Activates the Auto Start and shows the owner status for the current Auto Start. If the application name is different from the application module that you are currently using, i.e. if the Auto Start has been set up with a different application module, you cannot change the set-up parameters. If you want to change the owner status for the Auto Start you can do so by using the ◀ ▶ cursor keys. When you have changed the owner status to the current application name you can change the parameters as desired.

Setting Start Time for an Auto Start

The Date and the Time fields are used for setting up month, day and time for the current Auto Start. The Mediator will be automatically switched on shortly (approx. 30 s) before the set time, so that it is ready for measurement at the specified time.

Selecting the Set-up for an Auto Start

With the Use Setup No. field a stored measurement set-up (1 to 4) can be attached to an Auto Start. When the Auto Start is executed, the specified measurement set-up is automatically loaded.

4.1.9 Setting the Occupational Health Parameters

You can measure noise dose levels by setting up the parameters in the Occupational Health Window, see Fig. 4.8.



Ok	Cancel
Occ. Health <input type="checkbox"/>	
Exposure Time:	07:30
Criterion Lev.:	100dB
Threshold Lev.:	0dB
2nd Exch. Rate:	4dB

Fig. 4.8 The Occupational Health Window

The Mediator can measure A-, C- or Lin.-weighted dose levels with Exchange rates of 3 dB (L_{eq}) and 4 or 5 dB (L_{av}) levels with A- and C-weighting. Select the desired dose parameter in the Measurement Window. The L_{eq} value (with exchange rate of 3) is always measured. L_{av} is measured simultaneously, but before measurement you must select exchange rate of 4 or 5 dB in the General Window. Note that the 4 or 5 dB L_{av} parameters are measured with F or S time weighting.

The dose level represents the amount of received sound energy expressed as a percentage of the daily allowed dose (100% level).

Setting the Exposure Time

In the Exposure Time field you can set, in hours and minutes, the actual time that you are exposed to noise during a workday. The noise dose calculation is based on the time you are exposed to the noise (Exposure Time) relative to a normal 8 hour workday.

Specifying the Criterion Level

The Criterion Lev. sound level is specified in your local standard. It is the level of a sound which, continuously applied for eight hours, results in a 100% criterion exposure.

The calculation of the noise dose level is based on the criterion level and the exposure time.

Specifying the Threshold Level

The Threshold Lev. level may be specified in your local standard. Any sound levels below the threshold value do not contribute to the Dose measurement data. For example, if you set the threshold value to 80, any sound levels below 80 dB are not taken into consideration by the instrument when it calculates integrated values (L_{eq} , L_{av} Dose).

4.1.10 Saving Measurement Set-ups

You can save up to four measurement set-ups for each application package in the Save Setup Window, see Fig. 4.9.



Fig. 4.9 The Save Setup Window

When you save a measurement set-up, you save all the parameters in the Measurement Set-up menu (see section 4.1.2).

Ensure that these parameters are set up correctly before you proceed.

Saving the Current Measurement Set-up

- 1 - 4

In the Save in no. field, select the number which you want to save the current set-up as. The selected set-up is saved when you press the <Ok> Softkey.

4.1.11 Recalling Measurement Set-ups

Measurement set-ups are recalled in the Recall Setup Window, see Fig. 4.10.

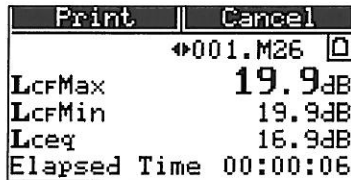

Fig. 4.10 The Recall Setup Window

When you recall a measurement set-up, you recall all the parameters listed under Recalling Measurement Set-ups above.

Recalling a Measurement Set-up

- 1 - 4
- Default

From the Recall from no. field you can recall a stored set-up by entering the desired set-up number. The stored set-ups are identified by the date they were saved. The date for a stored set-up appears in the bottom line. You can also recall the factory default set-up. Refer to section 10.2 in Appendix 1 for a list of default parameters. The selected set-up is recalled when you press the <Ok> Softkey.

Chapter 5

Measuring

5.1	Calibrating.....	5-2
	Introduction	5-2
	Calibrating the Mediator	5-3
	Checking the Calibration	5-7
	Calibration History	5-7
5.2	Starting a New Measurement	5-8
5.3	Pausing a Measurement	5-9
5.4	Continuing a Measurement.....	5-9
5.5	Measuring in $1/1$ - and $1/3$ -octave bands	5-10
5.6	Setting the Mediator to Start Automatically	5-10
5.7	Changing Displayed Measurement Parameters.	5-11

5.1 Calibrating

5.1.1 Introduction

When to Calibrate

The standards recommend that you calibrate your sound level meter before each set of measurements (see section 5.1.2) and check the calibration after each set (see section 5.1.3).

Connecting a recommended microphone extension cable (see section 2.2.5) has no effect on Mediator's calibration. Therefore, you do not have to recalibrate after connecting one of the recommended microphone extension cables.

Principle of Calibration

Mediator uses a sensitivity value to check for drift. This is shown in the Calibration Window. When calibrating, Mediator first checks the calibration signal against the calibration level you have specified. It shows you the new sensitivity value required for correct calibration, the current (previous) and the initial (factory) sensitivity values and asks if you want to recalibrate. If you press <Accept>, Mediator calibrates itself according to this new calibration level (i.e. it adjusts the sensitivity according to the calibration level).

During this procedure, Mediator is automatically set to use the reference measurement range and settings. To ensure that a calibration is valid, Mediator compares the output from both detectors during calibration. It also ensures that the calibration level is stable during calibration. The maximum allowed standard deviation is 0.1 dB over a 4 second period.

Calibrating for Free-field or Diffuse Field Measurements

The sound level meter is calibrated in the same way for free-field measurements (according to IEC) and diffuse field measurements (according to ANSI). However, the calibration levels for some calibrators may be different, depending on which measurements are to be made. See the calibrator's user manual for more details. The correction filters are automatically

set to Frontal and WindscreenOff during calibration. After calibration they return to the previous settings.

Which Calibrators Can I Use?

Mediator is normally used with the supplied microphone Type 4188. The initial (factory) calibration is performed with the microphone supplied with Mediator. However, an unspecified transducer, e.g. another microphone or a hydrophone may be used. In principle, since you specify the calibration level, any calibration level in the range 50 to 200 dB can be used, depending on the transducer.

Microphones are usually calibrated at 94, 114 or 124 dB. The default value for Mediator is 94.0 dB. Sound Level Calibrator Type 4231 provides 94 or 114 dB SPL at 1 kHz. Multifunction Acoustic Calibrator Type 4226 provides 94, 104 or 114 dB SPL. Hydrophone Calibrator Type 4229 generates 151 to 166 dB re 1 μ Pa at 250 Hz.

Each calibrator is slightly different. The actual calibration level is not necessarily equal to the nominal calibration level. It is, therefore, important to set the calibration level to the one given on the calibration chart for the calibrator used.

5.1.2 Calibrating the Mediator

For day to day calibration, you only need to calibrate at one level at one frequency. In order to comply with the standards, calibrate the sound level meter with a reference signal of 94 dB* at 1 kHz.

To calibrate with microphone Type 4188:

1. Switch on the Mediator and press the \square Calibrate key.

Select Calibration from the Calibration menu, see Fig. 5.2.

* When using Type 4231 set the calibration level to 93.9 dB for free-field calibration according to IEC standards. For pressure calibration according to ANSI standards, set the level to 94.0 dB.

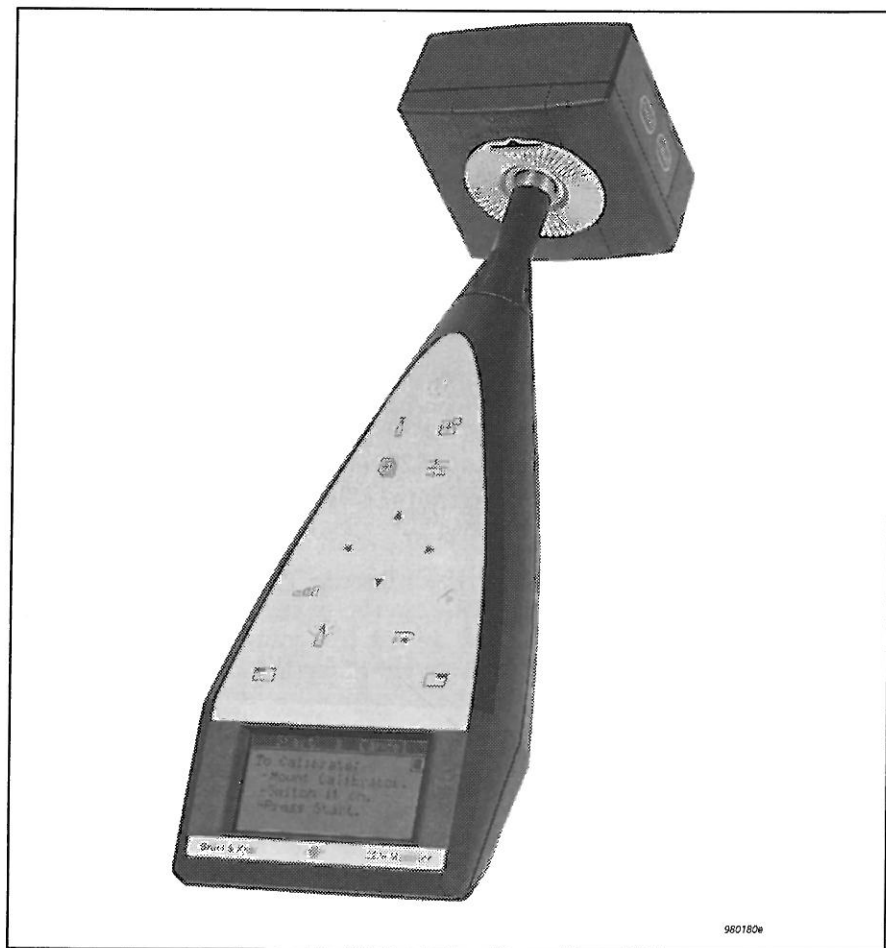

Fig.5.1 Fitting Sound Level Calibrator Type 4231 onto the Mediator. Multifunction Acoustic Calibrator Type 4226 is fitted in a similar way (see its manual)

The Current Calibration Window appears as shown in Fig. 5.3.

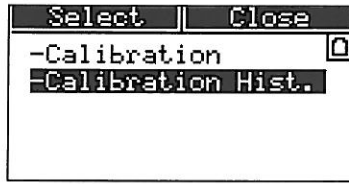

Fig.5.2 The Calibration menu

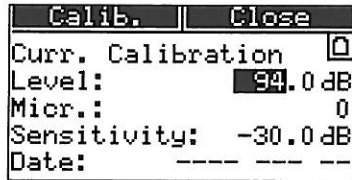

Fig.5.3 The Current Calibration Window

- Microphone — shows the serial number for the Type 4188 supplied with the Mediator or if an unspecified transducer has been used for the calibration
 - Calibration Level — the calibration level that was specified for the current calibration. The Calibration Level must be within 50 to 200 dB and can be stepped in 1 and 0.1 dB steps. The default value is 94.0 dB
 - Sensitivity — the sensitivity value calculated by Mediator as a result of the current calibration. You cannot access this field
 - Date — the date for the current calibration. You cannot access this field
2. Check that microphone Type 4188 is selected and that the calibration Level is set to 94.0 dB (or the calibration level specified on the calibrators calibration chart).
 3. Press Calib. and Fit the calibrator carefully onto the sound level meter and rest the sound level meter on a table or other flat surface. Ensure that the calibrator fits snugly on the microphone (see Fig.5.1).

4. For the multifunction acoustic calibrator, set it up to calibrate at 94dB and 1 kHz (see the calibrator's instruction manual).
5. Switch on the calibrator.
The calibrator emits a 1kHz calibration signal.
6. Press Start and wait until the calibration is finished.

If the calibration is successful the Calibration Result Window will appear as shown in Fig. 5.4.

Accept	Cancel
Result	<input type="checkbox"/>
Level:	94.0dB
New Sens.:	-29.7dB
Curr. Sens.:	-30.0dB
Init. Sens.:	-30.0dB

Fig. 5.4 The Calibration Result Window

- Calibration Level — the calibration level you have specified
 - New Sens. — the new sensitivity value calculated by Mediator as a result of the calibration
 - Current Sens. — the current sensitivity value that is valid until you press the Accept key. Comparing the New Sens. and the Current Sens. values gives you the option to evaluate the relative deviation since the last calibration
 - Initial Sens. — the factory sensitivity value. Allows you to evaluate the absolute deviation since the instrument was manufactured. If the New Sens. value deviates more than ± 1.5 dB from the Initial Sens. value, an error message will appear
7. Press Accept if the New Sens. value is within acceptable limits. The New Sens. value is implemented.

Press **Cancel** if you cannot accept the **New Sens.** value. A new calibration must be performed. This also applies if the **Calibration Error** warning appears.

- Check that the microphone has been fitted properly
- Check that the calibrator has been switched on and is working properly
- Check that the **Calibration Level** has been entered correctly
- External noise or vibrations may have affected the calibration
- Inspect the microphone to see if it has been damaged

5.1.3 Checking the Calibration

Follow the instructions given in section 5.1.2 until item 8. If the **New Sens.** value is similar to the **Current Sens.** value press the **Cancel** key to return to the main screen. Otherwise a recalibration is required.

5.1.4 Calibration History

Select **Calibration History** from the **Calibration** menu. The **Calibration History Window** will appear as shown in Fig. 5.5.

Print		Cancel	
DATE	SENS.	HIC.	<input type="checkbox"/>
INITIAL:			
-----	-30.0	4294367295	
HISTORY:			
98Jul09	-29.7	4294367295	

Fig.5.5 The Calibration History Window

The first line in the **Calibration History Window** always shows the initial (factory) calibration sensitivity and the serial number for the supplied microphone. In addition the

Calibration History Window contains information about the 20 latest calibrations. The following information is stored:

- Date — year, month and day for the calibration
- Sens. — the calculated sensitivity for the calibration
- Mic. — indicates whether the calibration was performed with the supplied 4188 microphone (serial number) or with an unspecified transducer (Unspec.)

Press Print if you want to print out the calibration history list.

5.2 Starting a New Measurement

1. Switch on the Mediator.
 - If another application program has been used, select the Basic SLM software from the System menu. Normally you do not need to change any parameters in the System menu (see section 4.1).
2. Calibrate the sound level meter as described in section 5.1.2.
3. Set up the parameters in the Measurement Setting menu, as described in section 4.1.2. Normally you will only need to:
 - Select a suitable measurement range. This reduces the risk of you having to change the range during a measurement in order to avoid overloads. Overloads reduce the validity of your results and changing the measurement range causes a reset.
 - If you want to measure according to IEC standards (i.e. free-field), set Sound Incidence to Frontal in the Correction Filters Window and simply point the sound level meter towards the sound source.
 - If you want to measure according to ANSI standards (i.e. diffuse-field), set Sound Incidence to Random in

the Correction Filters Window. The direction of the sound level meter is unimportant. If, however, the sound field is free, measure with the sound level meter at an angle of between 70 and 80° to the sound source.

- Select the desired measurement parameters in the Measurement Window.

4. Press $\frac{1}{2}$. The sound level meter starts measuring with the selected set-up.

Note: If you want to delete the measured data and set the buffer and timer to zero, press \rightarrow . If the measurement has been in progress for more than one minute, a warning is displayed and you must confirm that data is to be deleted.

5.3 Pausing a Measurement

The Pause mode of the Mediator allows you to store results in its memory or transfer results across the interface to a printer or computer.

Press $\frac{1}{2}$. The \parallel Pause symbol appears in the upper left-hand corner of the display. The clock stops counting the measurement time. The display and quasi-analogue scale continue to show the current status of the displayed parameters and input signal level, respectively. In Pause mode, however, no results or overload indications are added to the buffer.

5.4 Continuing a Measurement

Press $\frac{1}{2}$. The \blacktriangleright Measurement symbol is shown instead of the Pause symbol.

The clock continues counting the measurement time from the point at which it stopped. Results are added to the buffer.

5.5 Measuring in $1/1$ - and $1/3$ -octave bands*

Follow the instructions below to perform $1/1$ - and $1/3$ -octave band measurements.

1. Select $1/3$ -octave or $1/1$ -octave in the Bandwidth field as required (see section 4.1.4).
2. Select the centre frequency of the band in which you want to start the analysis, in the Freq. Wgt. field in the Weightings Window.
3. After you have completed the measurement in that frequency band, press $\frac{1}{3}$.
4. Store the measurement result in a file (see section 6.3).
5. Select the centre frequency of the band in which you want to continue the analysis. You are now ready to measure in the next frequency band.
6. Repeat steps 3 to 5 for the other bands in which you want to measure.

For automatic frequency analysis measurements Frequency Analysis Software BZ7123 is recommended. It is, however, possible to make a frequency analysis as a series of measurements in various frequency bands, as explained above.

5.6 Setting the Mediator to Start Automatically

The Mediator can be set to automatically start at any time and date within the next month (for example from 19th May to 18th June). To set up an Auto Start, refer to section 4.1.8.

* Only available with Mediator 2238-A-F (version with filter set installed)

5.7 Changing Displayed Measurement Parameters

The parameters available are listed in section 1.3. The selected parameters and the measurement values are shown at the bottom of the Measurement Window.

After a \rightarrow Reset, “---.-” is shown for all integrated values until after the first second. Instantaneous (and SPL) values are displayed continuously. This is because the levels are not yet available. Some of the averaged values take even longer, depending on the averaging times. When pressing ⏏ Pause all values are displayed continuously. The Bar Graph always shows the current SPL level (L_{XYinst}), regardless of the selected parameters.

The parameters can be changed while a measurement is in progress.

1. Use the \blacktriangledown cursor key to go to the desired parameter line in the Measurement Window.
2. Select the desired measurement parameter with the \blacktriangleleft \blacktriangleright cursor keys.
3. Return to the basic Measurement Window with the \blacktriangle or \blacktriangledown cursor keys.

When the time or frequency weightings or the exchange rate are changed, the associated measurement parameters in the Measurement Window are automatically changed and the counter is reset.

Note: If the measurement has been in progress for more than one minute, a warning is displayed and you must confirm that data is to be deleted.

Chapter 6

Data Handling

6.1	Data File System	6-2
	Saved Data.....	6-3
	Set-up Data.....	6-3
	Measurement Data.....	6-4
6.2	Selecting the Data Files Menu.....	6-4
6.3	Store Files	6-5
6.4	Print Options	6-5
6.5	Print.....	6-7
6.6	File Manager	6-7
	Recall Files.....	6-8
	Print	6-9
	Delete	6-9
	Delete All	6-9
	Disk Summary.....	6-10

6.1 Data File System

A total of 2000 data files of measurement results can be stored in memory. However, you can only store up to 500 files for each software package. Data files are copied from the buffer. All records are preserved when you turn off the instrument, except for the data in the buffer. Measurements can be stored automatically (during an Auto Start sequence) or manually (at any time after a measurement is stopped).

File Names

Measurements are saved in Mediator as files with a file name that consists of file number and an extension. In addition the files can be identified by the date and time when the file was saved.

Example:

001.M26 YYMMDD TTMMSS

File name: Consists of a three digit number from 000 to 500. Number 000 is used for back-up purposes, for example, in a power-down situation with flat batteries, the content of the buffer is saved in no. 000. File numbers are generated automatically as consecutive numbers.

Extension: The following extensions are used to identify the software package in which the files were made. The two digits in the extension correspond to the last digits in the type number:

M26: Basic SLM Software BZ 7126
M25: Enhanced SLM Software BZ 7125
M23: Frequency Analysis Software BZ 7123
M24: Logging SLM Software BZ 7124

ID: The date and time (YYMMDD TTMMSS) information is used to identify the files.

6.1.1 Saved Data

A basic measurement data file consists of a group of set-up data and a group of associated measurement data. The set-up data are:

- Serial number for the Mediator
- Measurement set-up
- Calibration data
- Measurement data

Measurement data are:

- Overall results
- RMS Broadband data
- Broad-band Peak data

6.1.2 Set-up Data

Measurement Set-up

All measurement set-up parameters that was used for the measurement.

Calibration Set-up (for individual measurements)

- Microphone type
- Sensitivity
- Calibration date

6.1.3 Measurement Data

Overall Results

- Start date
- Start time
- Elapsed time

- Overload
- Under-range

Broadband Data for Detector 1

L_{FMax} , L_{SMMax} , L_{IMax} , L_{FMin} , L_{SMin} , L_{IMin} , L_{eq} , L_{Ieq} , $L_{Aep,d}$,
 L_{AE} , E_A , L_{Fav4} , L_{Sav4} , Dose, $FDose_X$, $SDose_X$, AUX1, AUX2

Note: Only the parameters with the selected time weighting are saved.

Peak Data for Detector 2

- Number of peaks
- L_{XpkMax}

6.2 Selecting the Data Files Menu

The Data Files menu is used for saving and printing files and for accessing the File Manager. It contains the menu items shown in Fig. 6.1.

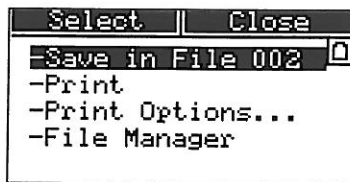



Fig. 6.1 The Data Files Window

1. The Data Files Window is accessed by pressing the  Data Files key when the instrument is paused. If the instrument is measuring you must press $\%$ to pause. Select the desired menu item with the \blacktriangle \blacktriangledown cursor keys.

This will also cause the <Select> and <Close> soft keys to appear.

2. Press the  <Select> softkey to enter the selection.
This will also cause the <Ok> and <Cancel> soft keys to appear.





6.3 Store Files

Automatically Saved Files

Measurements that are made with at preset measurement time are stored automatically with consecutive numbers.

If the Mediator switches off because of flat batteries, the content of the buffer is saved in file no. 000.

How to Store the Current Measurement Manually

1. Press the  Pause/Continue key to pause the measurement.
2. Press the  Data Files key to display the Data Files menu.
3. Press the  <Select> softkey or the  cursor key to store the measurement with the displayed file name. A “Saving File ...” message is displayed while saving takes place.

6.4 Print Options

Before you print a file or the contents of the buffer, you should select which measurement parameters you want to print out. The Print Options list applies to both the Print function for the buffer as well as the Print function in the File Manager.

Setting the Print Options

1. Select Print Options from the Data Files menu.

2. Use the cursor keys to tag the parameters that you want to print out. Use the ◀ ▶ cursor keys to tag (+) or untag a long list of parameters. Note that parameters that are already tagged will be de-selected. If you only want to tag or untag a few parameters, select the desired parameter with the ▲ ▼ cursor keys and tag or untag with the ◀ ▶ cursor keys. The following parameters can be printed:

- L_{MAX}
- L_{MIN}
- L_{AFTm5}
- L_{eq}
- L_{Ieq}
- L_{Aep,d}
- L_{AE}
- E_A
- L_{av4}
- Dose
- Dose4
- #Peaks
- L_{pkmax}

3. Press <Close> when you have tagged the desired parameters.

6.5 Print

Simply select the Print option when you have connected the printer (refer to section 7.1) and set up the desired parameters in Print Options (see above). A “Printing ...” message is displayed while the print file is being transferred.

6.6 File Manager

The File Manager is used to give an overview of the data files in the memory and has options for recalling, printing and deleting these files. The Disk Summary option shows the memory status.

File List

When you select the File Manager option from the Data Files menu, you get at file list similar to the first screen picture illustrated in Fig.6.2. A file is identified by the file

Menu	Cancel	Menu	Cancel
001.H26	98Jul09 11:10	001.H26	0.4 kByte
002.H26	98Jul09 11:14	002.H26	0.4 kByte
003.H26	98Jul09 11:16	003.H26	0.4 kByte
004.H26	98Jul09 11:22	004.H26	0.4 kByte
005.H26	98Jul09 11:23	005.H26	0.4 kByte

Fig.6.2 The File List in the File Manager menu. The list is shown with both dates and file sizes

name and extension and the date and time it was saved. Pressing the  Data Files key when the File List is displayed will show the file sizes instead of the dates. A single file in the Basic module take up approximately 1kbyte of memory.

Tagging Files

Use the cursor keys to tag the files that you want to select. Use the ◀ ▶ cursor keys to tag (+) or untag a long list of files. Note that files that are already tagged will be de-selected. If you only want to tag or untag a few parameters, select the desired parameter with the ▲ ▼ cursor keys and tag or untag with the ◀ ▶ cursor keys.

Note: Whenever you leave the File Manager all file tags will be deleted.

Press the  <Menu> softkey to show the options in the File Manager Options Window, see Fig. 6.3.



Fig. 6.3 The File Manager Options Window

6.6.1 Recall Files

Select Recall from the File Manager Options Window to recall all the tagged files from the File List.

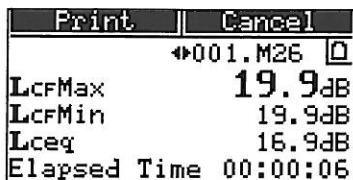



Fig. 6.4 The Recall Files Window

The Recall Files Window contains the same parameter fields as the Measurement Window (except for instantaneous values). The Bar Graph is replaced with a File Number field. When the basic Recall Files Window is selected, you can scroll through the recalled files by using the   cursor keys. The <Print> option will print the currently recalled file with the parameters from the Print Options list.

6.6.2 Print

Select Print from the File Manager Options Window to print all the tagged files from the File List. The Print Window will appear to show which file is currently being printed.

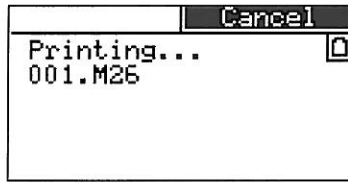

Fig.6.5 The Print Window

6.6.3 Delete

Select Delete from the File Manager Options Window to delete all the tagged files from the File List. A delete prompt will appear to confirm that you want to delete the selected files. The File List will appear to show the remaining files.

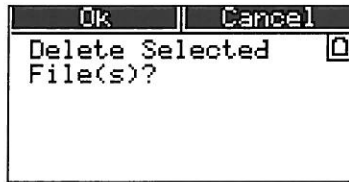

Fig.6.6 The Delete Window

6.6.4 Delete All

Similar to the Delete option above, except that all files (tagged and untagged) will be deleted.

6.6.5 Disk Summary

Select Disk Summary from the File Manager Options Window to get an overview of the disk memory.

The following parameters are displayed:

- Total: Shows the total disk space in kbytes
- Used: Shows the used disk space in kbytes

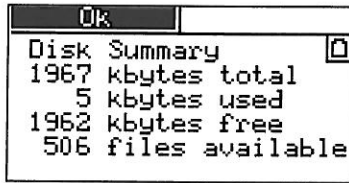

Fig. 6.7 The Disk Summary Window

- Free: Shows the total free disk space in kbytes
- Available: Shows the total number of files that can still be saved for the current application module

Chapter 7

Printing and Transferring Data

- 7.1 Output to a Printer..... 7-2
- 7.2 Transferring Data to 7815, 7820, 7821 and 7825. 7-2
- 7.3 Aux 1 and Aux 2 Output 7-3

7.1 Output to a Printer

7.1.1 Setting up for Portable Printer Type 2322

Mediator includes a standard serial port interface. We recommend using Portable Printer Type 2322 as the printing format has been optimized for this printer. However, it is possible to use an IBM Proprinter® compatible printer.

Connecting Type 2322

1. Switch off the Mediator and Type 2322 before connecting the serial interface cable
2. Connect the 9-pin connector on the cable to the 9-pin Serial Interface socket on the base of Mediator.

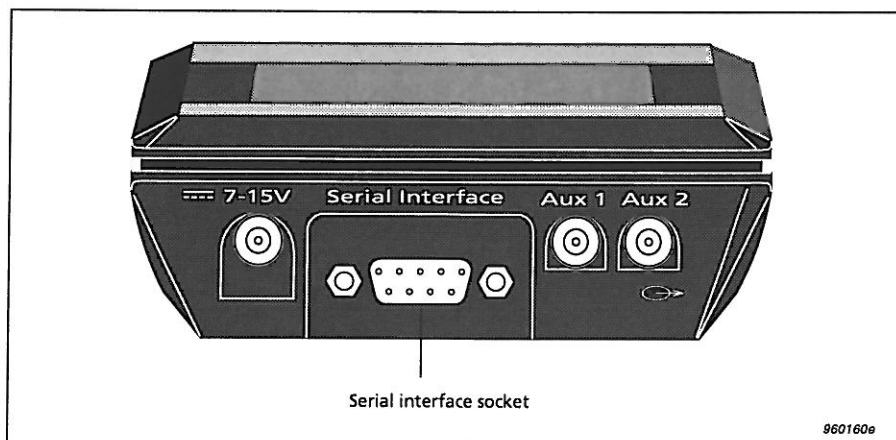

Fig. 7.1 Location of the serial interface connector

3. Carefully tighten the cable's connector screws to the screw holes in the sound level meter.
4. Connect the round connector on the cable (arrows facing upwards) to Type 2322.



Setting up Interface Parameters

Ensure that the interface parameters in the Printer Interface Window are set as follows:

- ☆ Baud Rate: 9600
- ☆ Handshake: XON/XOFF

7.1.2 To Print a Measurement

Connect the printer and set up the interface parameters as described above. If the printer has not been connected, you must save the measurement as a file (refer to File Manager in section 6.6 for printing files) before switching the Mediator off.

1. Press  to pause the measurement.
2. Press the  Data Files key to open the Data Files Window.
3. Select Print from the menu list. A “Printing ...” message is displayed while data is transferred to the printer.

Refer to Chapter 6 for details about setting up print options and printing files.

Measurement Print Format

A Measurement print includes:

1. Header
2. Settings (measurement parameters)
3. Calibration Data (Microphone, Sensitivity and Date)
4. Overall Results (Start Date/Time, Elapsed Time, Overload and Underrange)
5. RMS and Peak Measurement Results (selected measurement parameters, see section 6.4)

7.1.3 Calibration History

Connect the printer and set up the interface parameters as described above.

1. Press $\% \text{ } \square$ to pause the measurement.
2. Press the $\text{ } \square$ Calibration key.
3. Select Calibration History from the Calibration menu.
4. Press the $\text{ } \square$ Print key to print the Calibration History.

Calibration History Print Format

A Calibration History print includes:

1. Header
2. Calibration History (Date, Time, Sensitivity, Microphone and Initial Calibration)

7.2 Transferring Data to 7815, 7820, 7821 and 7825

Data export to a PC is normally made to one of the application programs: 7815 Noise Explorer™, 7820/7821 Evaluator™ or 7825 Protector™. The procedure for setting up the interface is identical for these programs. For installation of the application program, refer to the Installation Guide for the respective program.

1. If the default values have been changed, switch on the Mediator and set:

- ☆ Baud Rate: 38400
- ☆ Handshake: Hardwired

Refer to section 3.1.5.

Note: 38400 is the recommended baud rate. Depending on your system, a higher baud rate may be possible or a lower transfer rate may be necessary.

2. Switch off the PC and the Mediator.

Caution: When connecting the Mediator to the PC, ensure that both instruments are switched off. Otherwise they could be damaged.

3. Choose a free COM port on the PC. Normally the COM 1 or COM 2 port. Connect the Mediator to the PC via the 9-pin Serial Interface socket on the base of the Mediator using cable AO 1386. AO 1386 has 9-pin connectors at each end. A 9-pin to 25-pin adaptor is supplied with the cable for use with PC's with 25-pin serial connectors.
4. Switch on the PC and open the desired application program.
5. Select the New Measurement option in the Insert menu to open the Insert New Measurement Window.
6. Select SLM Type 2238 from the pull-down menu and click Setup. The Communication Window is displayed.
7. Set the appropriate COM port and Baud Rate parameters and click OK.
8. Click Next> in the Insert New Measurement Window. If properly connected, the Mediator is automatically switched on and measurement file data is transferred to the application program. Otherwise a Communication Error prompt is displayed. You must check that the cable is properly connected and that the interface parameters are set up correctly.

Note: Disconnect the Mediator from the PC after completion of data transmission. Leaving it connected risks draining the batteries because it might power on when the PC is switched off.

7.3 Aux 1 and Aux 2 Output

Aux 1

The AC signal emitted from the **Aux 1** Output socket is L-weighted or weighted with the frequency weighting selected for Detector 1. It can be used for recording noise signals on tape, transferring signals to an analyser or listening to the input on headphones.

Aux 2

A DC level corresponding to the instantaneous RMS (Fast) level is emitted from the **Aux 2** socket at the base of the sound level meter for recording on a plotter.

Chapter 8

Maintenance and Repair

8.1	Maintenance and Repair.....	8-2
	Care, Cleaning and Storage.....	8-2

8.1 Maintenance and Repair

The Mediator is designed and constructed to provide many years of reliable operation. However, if a fault occurs that impairs the sound level meter's correct function, then remove the batteries to prevent risk of further damage.

For more information about preventing or identifying faults or damage to your sound level meter, please read the other sections of this chapter.

For repair, contact your local Brüel & Kjær dealer.

8.1.1 Care, Cleaning and Storage

The Mediator is a precision instrument. When handling, storing, or cleaning your instrument, please take note of the following precautions:

Storing the Instrument

- Keep the sound level meter in a dry place
- For long-term storage, remove the batteries
- Do not exceed storage temperature limits of -25 to $+60^{\circ}\text{C}$ (-13 to $+140^{\circ}\text{F}$)

Cleaning the Instrument

If the instrument casing becomes dirty, then wipe it with a cloth lightly dampened with water. Do not use abrasive cleansers or solvents. Do not allow moisture to enter the microphone, connectors, or casing.

Handling the instrument

- Do not try to remove the microphone grid, you can easily damage the microphone in this way
- Do not attempt to open the instrument. There are no user-serviceable parts inside. If you think your instru-

ment requires service, then please contact your Brüel & Kjær dealer

- Do not allow the instrument to get wet
- Never mix different makes or types of battery
- Never mix new and old batteries
- Do not allow fully discharged batteries to remain inside the instrument
- Protect the instrument from impact. Do not drop it. Transport it in the supplied Shoulder Bag (KE 0323)
- Avoid large, sudden changes in temperature and humidity. Especially when there is risk of condensation inside the Mediator, for example, if it is very cold and you subject it to a hot and humid environment.

Chapter 9

Specifications

9.1 Specifications (2238–A and 2238–A–F)

Mediator Type 2238 conforms with both the existing Sound Level Meter Standards and with the more comprehensive and more stringent IEC 1672 (draft) standard. For the new standard some specifications are different, and some additional specifications are required

The different/additional specifications can be found in section 9.3

General Specifications:

Specifications apply to the 2238 Mediator fitted with the supplied microphone and preamplifier and running Basic SLM Software (supplied with each 2238 Mediator)

Note: All references to 1/3-octave bands or 1/1-octave bands apply only to the Type 2238–A–F.

Standards:

Conforms with the following:

- EN 60651/IEC 651 (1979) Type 1 plus Amendment 1
- EN 60804/IEC 804 (1985) Type 1 plus Amendment 2
- Draft IEC 1672/EN 61672 — March 1998, Class 1
- ANSI S1.4 (1983) Type S 1
- ANSI S1.43–199X Type 1 (Draft 1993)

Supplied Microphone:

Type 4188 Pre-polarized Free-field 1/2" Condenser Microphone

Nominal Sensitivity: –30 dB re 1 V/Pa or 31.6 mV/Pa

Capacitance: 12 pF (at 250 Hz)

Supplied Microphone Preamplifier:

ZC 0030

Input Impedance: 10 GΩ/10.2 pF

Extension Cables: Available in lengths of 3 m and 10 m. No recalibration is required

Measuring Range:

At 1 kHz, the difference between the nominal upper boundary level on the least sensitive level range and the lowest sound pressure level measurable on the most sensitive level range.

A-weighted: 25 to 140 dB

C-weighted: 27 to 140 dB

Lin.: 33 to 140 dB

Linear Operating Ranges (worst Case A-weighted):

For the individual level ranges, at 1 kHz, the nominal upper boundary levels minus the lowest sound pressure level measurable with a noise margin of 5 dB.

With a Microphone Type 4188 of nominal sensitivity:

Upper limit	Lower limit	Max. peak level	Upper limit (CF = 10)
140 dB	60 dB	143 dB	123 dB
130 dB	50 dB	133 dB	113 dB
120 dB	40 dB	123 dB	103 dB
110 dB	30 dB	113 dB	93 dB
100 dB	25 dB	103 dB	83 dB
90 dB	25 dB	93 dB	73 dB
80 dB	25 dB	83 dB	63 dB

Inherent Noise level:

Inherent noise is the combination of the electrical noise and the thermal noise from the microphone at 20°C. Typical values with supplied microphone of nominal sensitivity (in dB) are given in the table below and in Fig. 9.1 and Fig. 9.2:

Weighting	Electrical noise (2238)	Thermal noise (4188)	Combined Noise
"A"	14	14.5	17.4
"C"	17	13.2	18.5
Lin. 5 Hz – 20 kHz	22	14.2	23

Primary Indicator Range:

The upper limit of each Primary Indicator Range is the same as the upper limit for CF (crest factor) = 10 of each range setting. The lower limit is either the upper limit –80 dB or one of the following values, whichever is highest

Linear	C-weighted	A-weighted
38 dB	32 dB	30 dB

Indicator Range:

0 to -80 dB relative to upper limit for each range setting

Frequency Weighting:

Fig. 9.3 shows the curves for the A, C and L frequency weightings. The microphone response is not included.

Resolution:

Discrete parameters: 0.1 dB
Broad-band Statistics: 0.5 dB

Detectors:

Simultaneous detection of RMS and Peak with independent frequency weightings

RMS Detectors

Time Weighting: The RMS detector facilitates three exponential time weightings (Fast, Slow, Impulse) according to IEC 651 Type 1 (factory checked to meet Type 0).

Frequency Weightings: A, C or L (also 1/1 and 1/3-octave bands with 223B – A – F)

Tone Burst Response: See Fig. 9.4

Peak detector:

L-weighting: Conforms to IEC 651 and IEC 1672

C-weighting: Conforms to IEC 1672

Rise Time < 100 μs (L-weighting)

Overload detector

Monitors all signal paths

Frequency Response:

The effect of the Mediator's casing on the frequency response is shown in Fig. 9.5. The frequency and directional responses of the Mediator are shown in Fig. 9.6, Fig. 9.7 and Fig. 9.8)

Measurements:

The available measurement parameters are listed in the table. RMS and Peak measurements run in parallel with individual frequency weightings

Symbol Key (for measurement parameters):

X: Frequency weighting A, C or L

V: Frequency weighting C or L

Y: Time weighting F, S or I

Measurement Control:

Manual control, or pre-set measurement time in the range 30 s to 99 h, 59 m, 59 s with automatic storage of measurement

Stored	Instantaneous (display only)
L _{Xeq}	L _{XYp}
L _{XYav4}	L _{XYInst}
L _{XYav5}	L _{Ypk}
L _{AE}	
L _{Aep,d}	
E _A	
L _{XYmax}	
L _{XYmin}	
L _{Xpkmax}	
Number of Peaks	
Dose% _A	
Dose% _{AY4}	
Dose% _{AY5}	
Overload%	
Underrange%	
Elapsed Time	
Start Time	
Start Date	
Time	

Auto Start:

The Mediator supports four Auto Starts which allow set-up of measurement start times up to a month in advance

Reference Conditions for Acoustic Calibration:

Using Sound Level Calibrator Type 4231 or Multifunction Acoustic Calibrator Type 4226

Type of Sound Field: Free-field

Reference Direction of Sound Incidence:

Frontal, perpendicular to microphone diaphragm.

Reference Sound Pressure Level: 94 dB

Reference Frequency: 1 kHz

Reference Temperature: +20°C (+68°F)

Reference Measuring Level Range: 50 – 130 dB (automatically set during calibration sequence)

Calibration Correction with Extension Cable: 0 dB

Calibration History: 20 most recent calibrations. The initial calibration value is stored for comparison with later calibrations

Display:

128×64 dot matrix display with backlight

Measurement Display: Range and quasi-analogue bar graph, plus four measurement parameters that can be freely selected from all available parameters during measurements

Memory:

2 Mbytes. Up to 500 measurement files can be stored, including time stamp, complete set-up and calibration data

Serial Printer:

Measurement data can be printed on Portable Printer Type 2322 or on an IBM Proprinter-compatible printer.

Measurement data can be output as a binary file for post-processing on a PC

Aux 1 Output:

Connector: 2-pin LEMO

AC Output Signal: Range-adjusted AC output, L-weighted or with the frequency weighting selected on the RMS detector. Short-circuit protected

Output: 1 V RMS corresponding to full-scale indication

Max. Load: 10 k Ω || 1 nF

Output Impedance: Typically 100 Ω

Aux 2 Output:

Connector: 2-pin LEMO

DC Output Signal: DC version of signal on RMS detector 1 (Fast, Inst). Delayed 0.8 s. Short-circuit protected

Output: 0 to 4.0 V DC, (50 mV/dB)

Update Rate: 160 times per second

Max. Load: 10 k Ω || 1 nF

Output Impedance: Typically 100 Ω

Clock:

Real-time (calendar)

Serial Input/Output:

Conforms to EIA/TIA 574 (RS-232), coupled as Data Terminal Equipment (DTE). Cable (AO 1386) is supplied with the Mediator

Connector: 9-pin D-type male

Baud Rates: 4800, 9600, 19200, 38400 and 115200

Word Length: 8 bits, no parity, 1 stop bit

Serial Interface:

Handshake: Hardwired, Modem

Printer Interface:

Handshake: XON/XOFF, Hardwired

Settling Time:

From Power On: <10 s

Environmental Effects:

Storage Temperature: -25 to +70°C (-13 to +158°F)

Operating Temperature: -10 to +50°C (14 to 122°F)

Effect of Temperature: <0.5 dB (-10 to +50°C)

Effect of Humidity: <0.5 dB for 30% < RH < 90 % (at 40°C, 1 kHz)

Batteries:

Four 1.5 V LR6/AA alkaline cells

Lifetime (at room temperature): Typically >10 hours. Automatic switch-off when battery voltage sinks below threshold, to avoid invalid measurements

Indicator: Warning on display when less than 15 minutes of lifetime is remaining

Internal Back-up Battery: Keeps clock and data files operating for at least 6 months (typically) if fully charged. The back-up battery is charged from the main batteries. Charging time: approx. 10 hours

External DC Power Supply:

Voltage: Regulated 7 to 15 V

Voltage Ripple: < 20 mV_{peak} to peak

Power: Approximately 150 mA at 7 V (approx. 210 mA with filter set)

Centre Pin: Positive

Weight and Dimensions:

460 g (with batteries), 257×97×41 mm

Language:

Each instrument is loaded with English, German, French, Italian and Spanish text. You can select any of these languages at any time

9.2 Additional Specifications for 2238-A-F (Version with Filter Set Installed)

Standards:

Conforms with the following:

- EN61260/IEC 1260 (1995) Octave and 1/3-octave Bands Class 1
- ANSI S1.11–1986 Octave and 1/3-octave Bands, Order 3, Type 1-D. Optional Range

Octave and 1/3-octave Band Filters:

Conform to IEC 1260 (1995) and ANSI S1.11–1986.

Frequency Rating System: Base 10

Reference Attenuation: 0 dB

Linear Operating Range: As Indicator range

Nominal Octave Band Centre Frequencies: 31.5 Hz, 63 Hz, 125 Hz, 250 Hz, 500 Hz, 1 kHz, 2 kHz, 4 kHz, 8 kHz

Nominal 1/3-octave Band Centre Frequencies: 20 Hz, 25 Hz, 31.5 Hz, 40 Hz, 50 Hz, 63 Hz, 80 Hz, 100 Hz, 125 Hz, 160 Hz, 200 Hz, 250 Hz, 315 Hz, 400 Hz, 500 Hz, 630 Hz, 800 Hz, 1 kHz, 1.25 kHz, 1.6 kHz, 2 kHz, 2.5 kHz, 3.15 kHz, 4 kHz, 5 kHz, 6.3 kHz, 8 kHz, 10 kHz, 12.5 kHz

Batteries:

Lifetime (at room temperature): With filter selected: Typically >7 hours

9.3 Specifications According to IEC 1672 (2238–A and 2238–A–F)

Steady Level Linearity at 1kHz:

This is the nominal upper boundary levels minus the lowest sound pressure level that can be measured with maximum 0.3 dB nonlinearity within a 10 dB step. Nonlinearity is due to inherent noise, which must be at least 13 dB below the lower limit. Inherent noise is the combination of the electrical noise and the thermal noise from the microphone at 20°C. See Fig. 9.1 and Fig. 9.2.

For any level range, the upper limit is the upper boundary of the range. The lower limit is either the upper limit –80 dB, or one of the following values, whichever is highest:

Linear	C-weighted	A-weighted
41 dB	35 dB	33 dB

Peak-C Ranges:

For any range, the upper limit is the upper boundary of the range +3 dB. The lower limit is either the upper limit –63 dB, or 60 dB (L_{Vpk} (v = frequency weighting L or C)), whichever is highest

Range of Integration Time:

Time Averaged Sound Levels and Sound Exposure Levels can be measured over time intervals ranging from 1 s to >10 months (month of 31 days)

Inherent Noise:

Typical time averaged sound levels for integration times of 1 minute are shown in Fig. 9.1 and Fig. 9.2 for a Mediator fitted with a microphone Type 4188 of nominal sensitivity and exposed to a very low sound level.

Broad Band values for Fast and Slow time weighted measurements are:

Weighting	Fast	Slow
A	<20 dB	<20 dB
C*	21 dB	20 dB
Lin*	24 dB	23 dB

* Average of 10 readings taken randomly over a time interval of 1 minute

Test Information:

Microphone Reference Point: 1.3 mm behind the front of the protection grid.

During test the microphone signal can be substituted by an electrical signal input to an adapter WA 0302 (13 pF) which replaces the microphone. For a calibration factor of 0 dB the relationship between applied voltage and reading in SPL follows the table below

Applied Voltage	34 mV	6.76 V
SPL	94 dB	140 dB

Note: Due to stray capacitance an attenuation of 0.6 dB may result with WA 0302

Input Voltage Maximum: 15 V_{peak-peak}

EMC

Classification Group: X

Reference Direction for Testing Radio Frequency Susceptibility: Microphone facing antenna

9.4 Effect of Accessories:

Fig. 9.16, Fig. 9.17 and Fig. 9.18 show the typical effect of various accessories on the frequency response of Mediator

CE	CE-mark indicates compliance with: EMC Directive.
EMC Emission	<p>EN 50081-1: Generic emission standard. Part 1: Residential, commercial and light industry.</p> <p>EN 50081-2: Generic emission standard. Part 2: Industrial environment.</p> <p>CISPR 22: Radio disturbance characteristics of information technology equipment. Class B Limits.</p> <p>FCC Rules, Part 15: Complies with the limits for a Class B digital device.</p>
EMC Immunity	<p>EN 50082-1: Generic immunity standard. Part 1: Residential, commercial and light industry. RF immunity implies that sound level indications of 50 dB or greater will be affected by no more than 0.5 dB.</p> <p>EN 50082-2: Generic immunity standard. Part 2: Industrial environment. RF immunity implies that sound level indications of 65 dB or greater will be affected by no more than 0.5 dB.</p>
	These levels of immunity are 9 dB better than required by IEC 1672.
Note: The above conformance is guaranteed only when using the included/optional accessories.	

Brüel & Kjær reserves the right to change specifications and accessories without notice

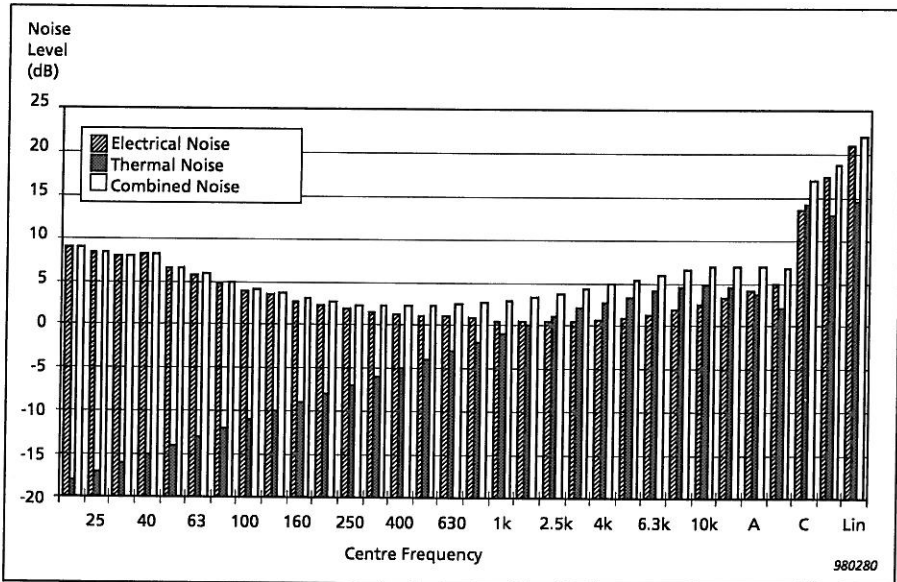

Fig. 9.1 The three components of inherent noise in each 1/3-octave band and in the broad bands A, C and L (5 Hz – 20 kHz)

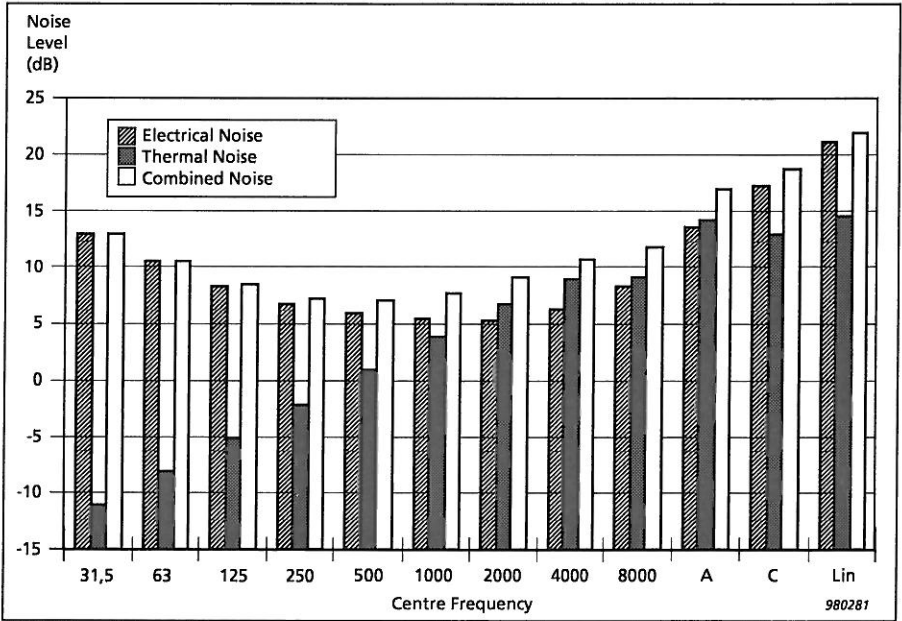

Fig.9.2 The three components of inherent noise in each octave band and in the broad bands A, C and L

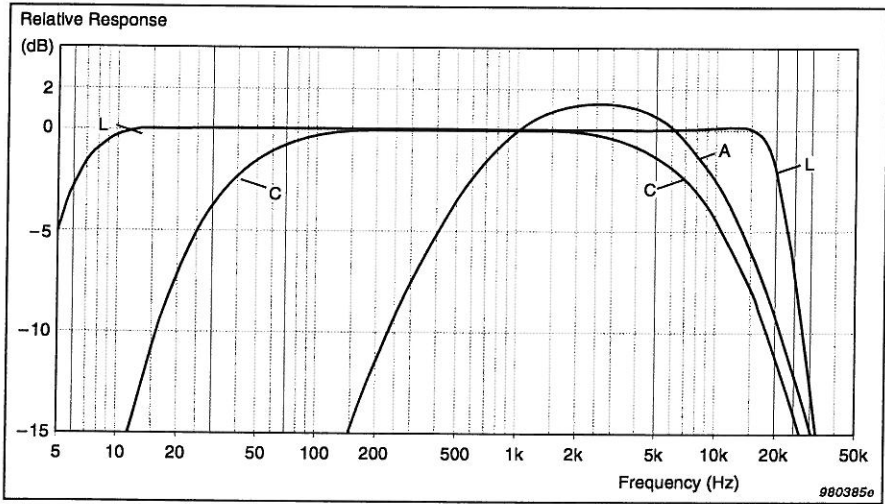

Fig.9.3 Curves for the A and C and L weightings. The curves do not include the microphone response

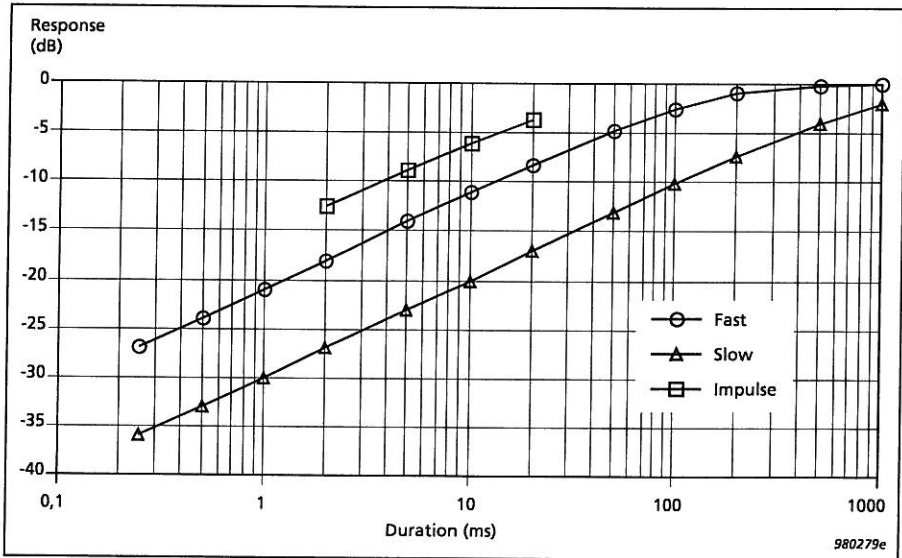

Fig.9.4 Curves showing the detector response of Mediator to 4kHz tone bursts of various durations

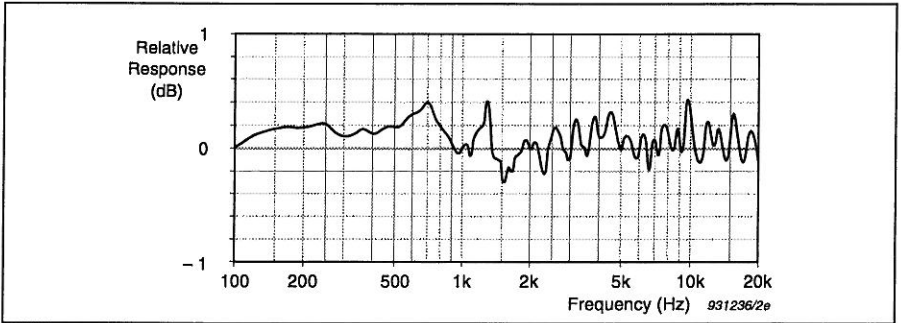

Fig.9.5 Effect of Mediator's casing on frequency response

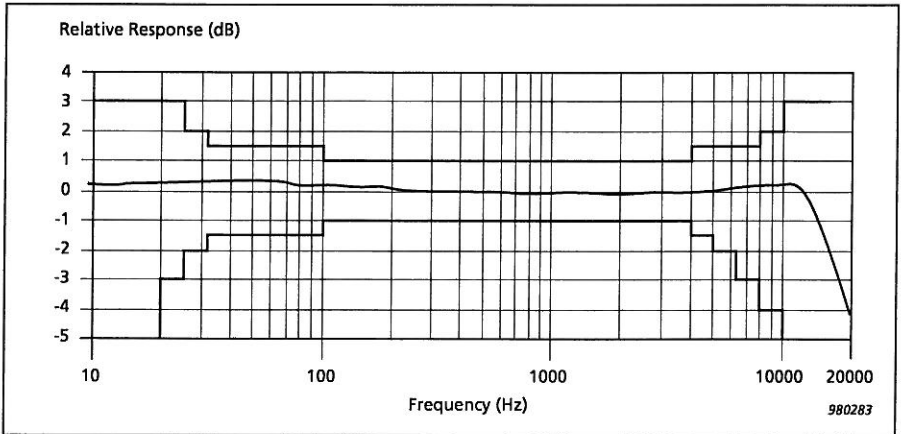

Fig.9.6 Free-field frequency response of Mediator fitted with the supplied microphone Type 4188. IEC 651 Type 1 tolerances are also shown

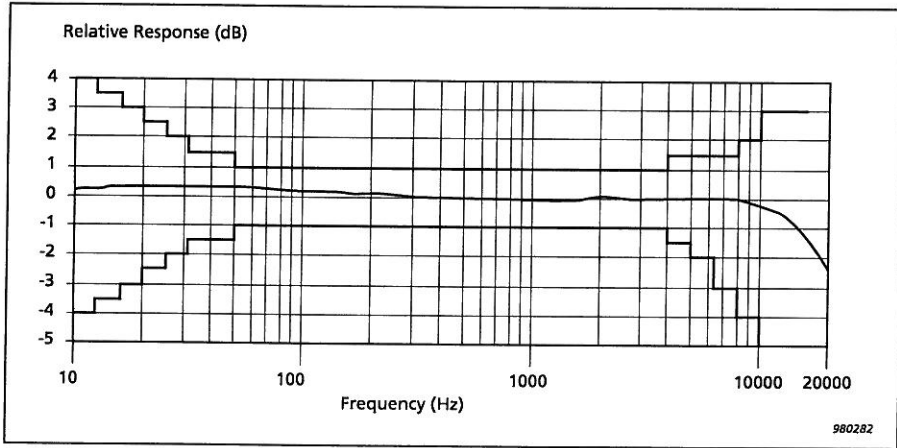

Fig.9.7 Random incidence frequency response of Mediator (random incidence filter selected) fitted with the supplied microphone Type 4188. IEC 651 Type 1 tolerances are also shown

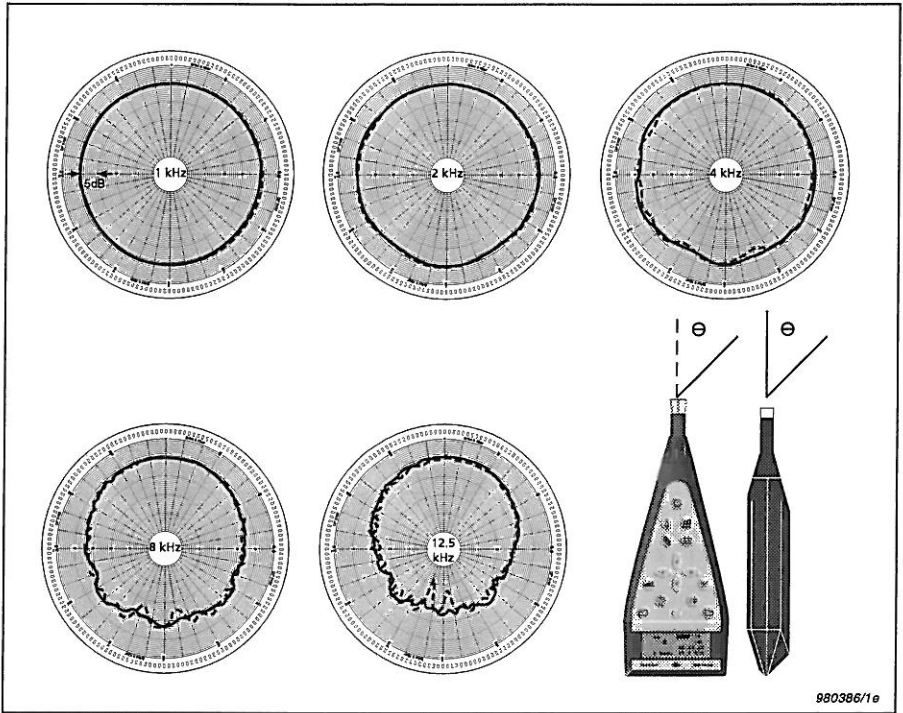

Fig.9.8 Directional characteristics of the Mediator fitted with the supplied microphone Type 4188. Characteristics measured at 1, 2, 4, 8 and 12.5 kHz

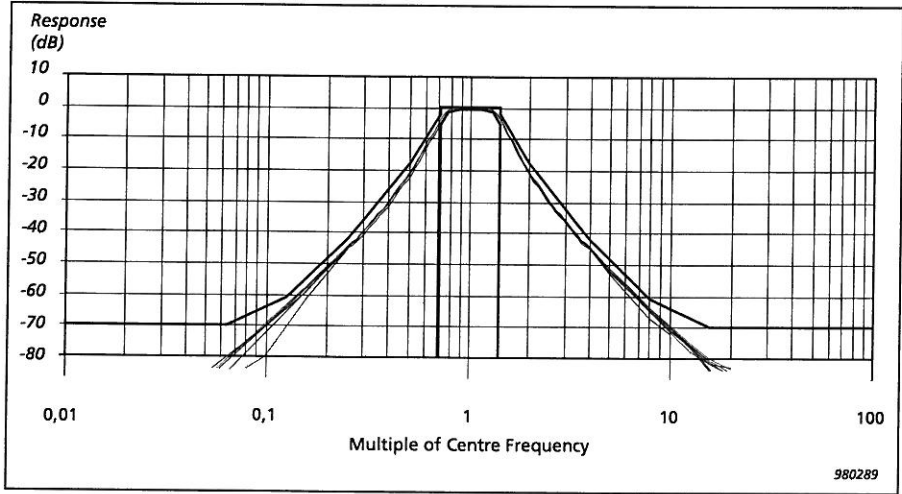

Fig.9.9 Curves showing the shape of the octave-band filters (from 0 to -80 dB). IEC 1260 tolerances are also shown

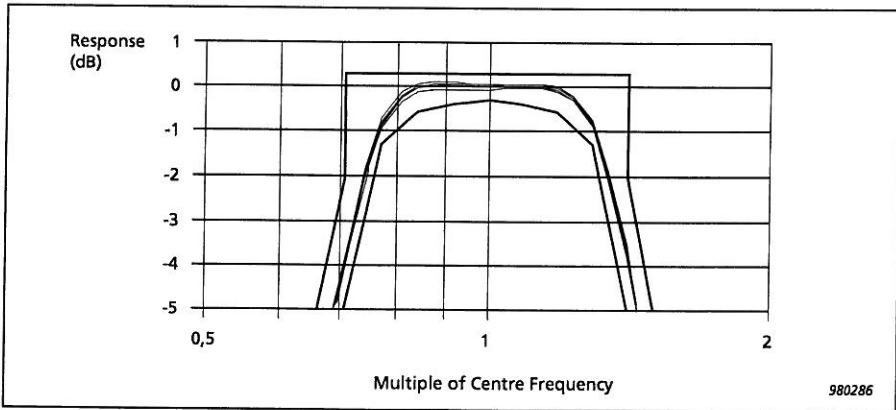

Fig.9.10 Curves showing the shape of the octave-band filters (from 0 to -3.5 dB). IEC 1260 tolerances are also shown

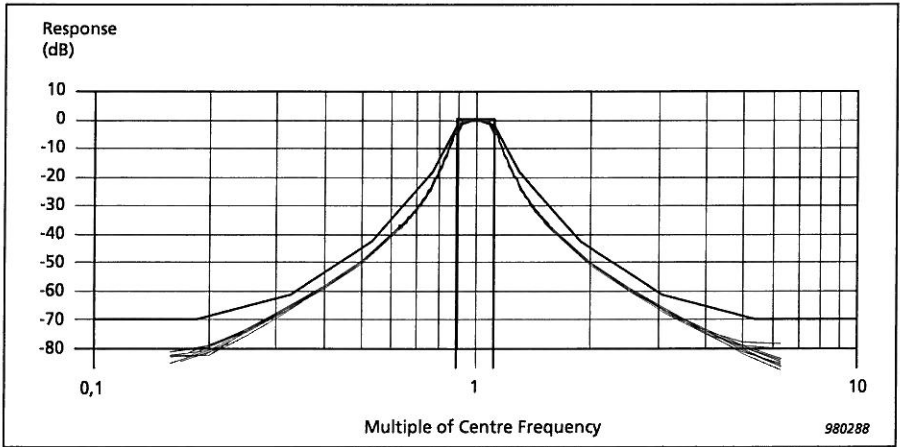

Fig.9.11 Curves showing the shape of the $1/3$ -octave-band filters (from 0 to -80 dB). IEC 1260 tolerances are also shown

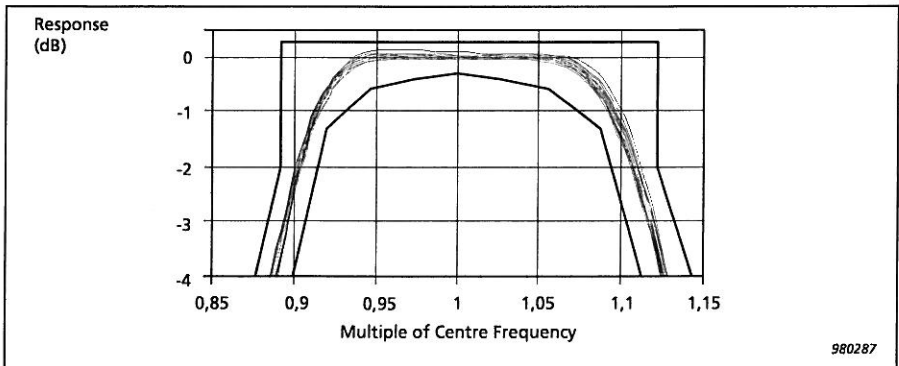

Fig.9.12 Curves showing the shape of the $1/3$ -octave-band filters (from 0 to -4 dB). IEC 1260 tolerances are also shown

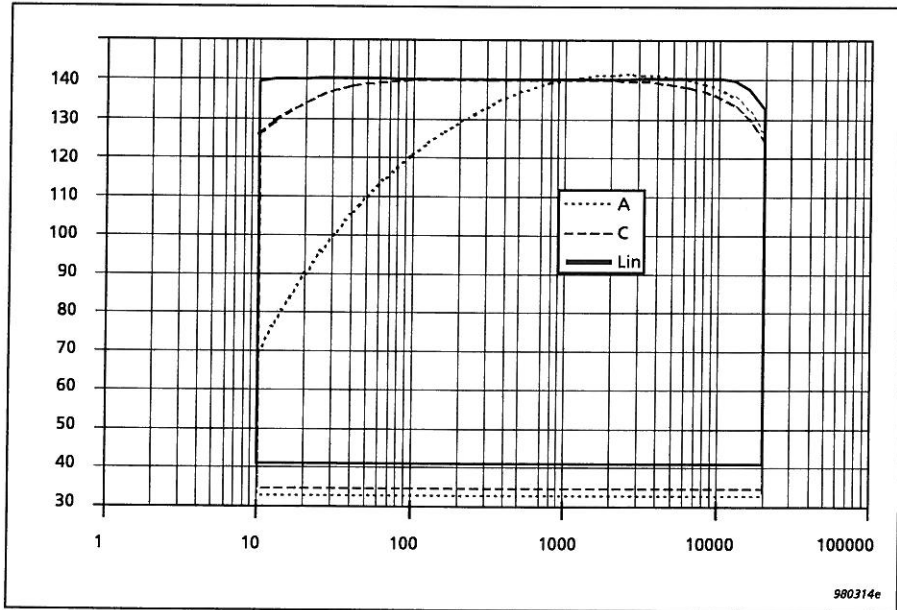

Fig.9.13 Maximum sound pressure levels that can be measured within tolerance limits of IEC 1672, A- and C-weighted and L

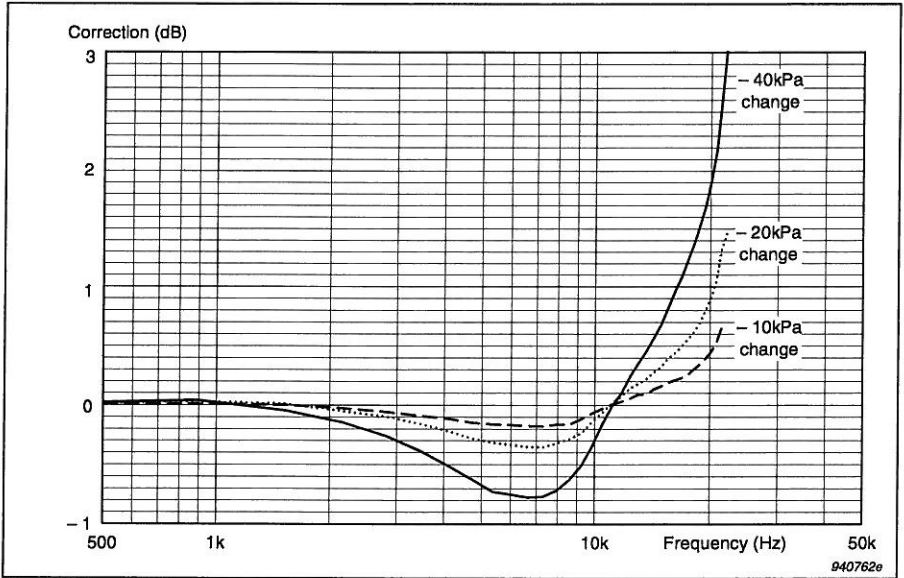

Fig.9.14 Typical variation in frequency response (normalized at 250Hz) as a function of change in ambient pressure, relative to 101.3 kPa (Type 4188)

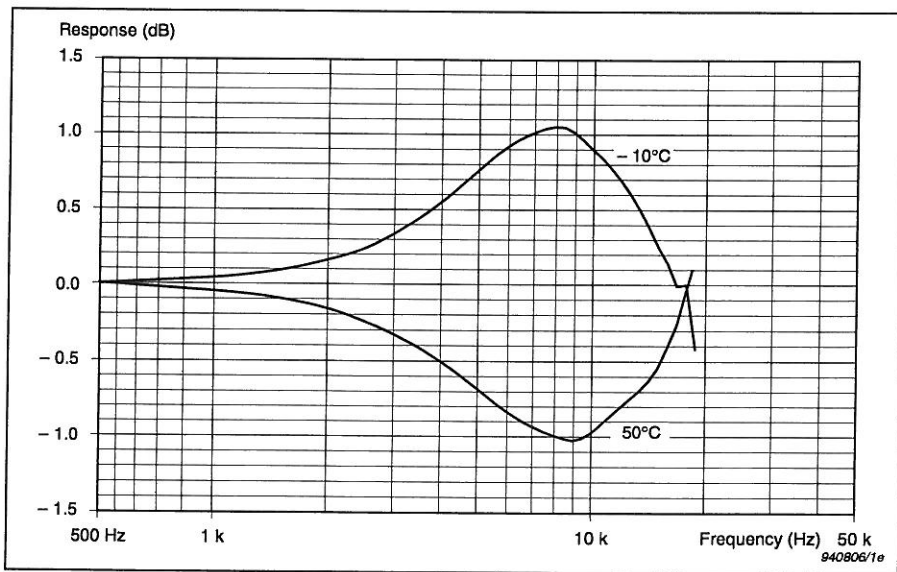

Fig.9.15 Typical variations in frequency response as a function of temperature, relative to the response at 20°C (Type 4188)

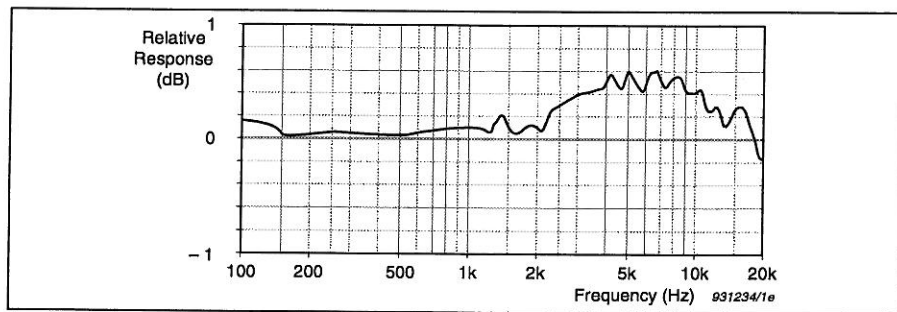

Fig.9.16 Influence of Protective Cover UA 1236 on Mediator's frequency response

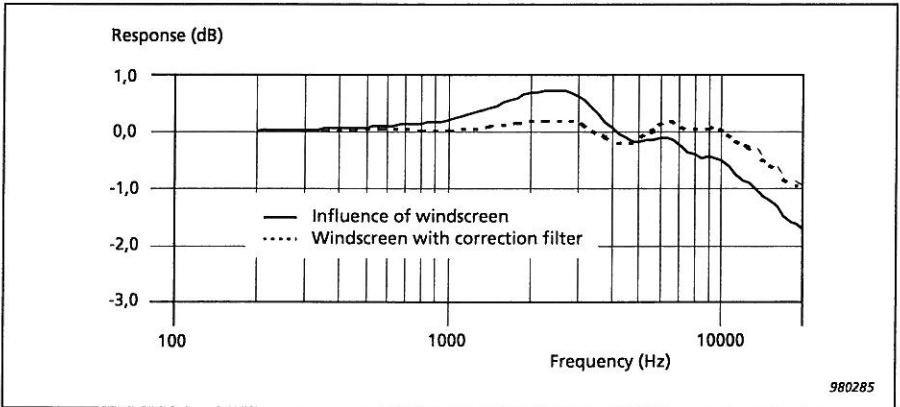

Fig.9.17 Influence of Windscreen UA 0237 on Mediator's frequency response, with and without the windscreen correction filter

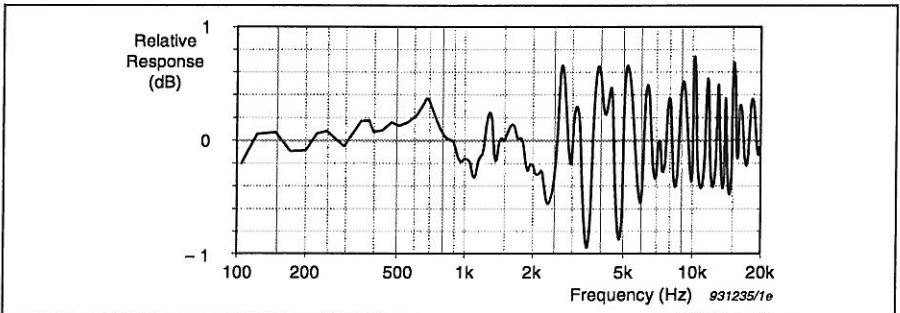

Fig.9.18 Influence on Mediator's frequency response when mounted on Tripod UA 1251

9.5 Accessories Included:

Type 4188:	Prepolarized Free-field $\frac{1}{2}$ " Condenser Microphone
ZC 0030:	Microphone Preamplifier
AO 1386:	9-pole Cable with 25-pole Adap- tor (for computer and serial printer)
KE 0323:	Shoulder Bag
UA 1236:	Protective Cover
QB 0013:	4 Alkaline Batteries

9.6 Optional Accessories

AO 0560/0409:	Microphone Extension Cable (10 m)
AO 0561/0408:	Microphone Extension Cable (3 m)
ZG 0386	Power Supply (European ver- sion)
ZG 0387	Power Supply (UK version)
ZG 0388	Power Supply (US version)

Chapter 10

Appendix 1: General

10.1	Exchange Rate	10-2
10.2	List of Default Parameters	10-4
10.3	Interface Errors	10-6
10.4	Messages and Warnings.....	10-8
10.5	Error messages	10-12

10.1 Exchange Rate

When measuring noise for the evaluation of hearing risk, the time factor has an important influence.

It is generally assumed that doubling the noise energy also doubles the hearing risk. This means that if the noise energy is doubled (i.e. it increases by 3 dB) the allowed exposure time should be halved.

Thus, as the equal energy concept requires a halving of the exposure time for a 3 dB increase in level (L_{eq}), it is said to have an Exchange Rate of 3 dB. This is standardized by ISO.

However, in the USA, the OSHA regulation allows a 5 dB increase in level for each halving of the exposure time (i.e. the Exchange Rate is 5 dB). It therefore uses an L_{av} with this Exchange Rate. This L_{av5} (or L_{OSHA}) has a different relationship between level and time than the equal energy concept standardized by ISO.

This is shown in Fig. 10.1. Going from an exposure time of 8 hours to 4 hours allows an increase of 3 dB in the L_{eq} in accordance with ISO, but an increase of 5 dB in the L_{AV5} in accordance with OSHA.

An Exchange Rate of 4 dB also exists (L_{av4} or L_{DOD}).

L_{eq} and $L_{EP,d}$ are always measured based on a 3 dB Exchange Rate. The second Exchange Rate (4 or 5 dB) determines whether L_{av4} or L_{av5} is measured.

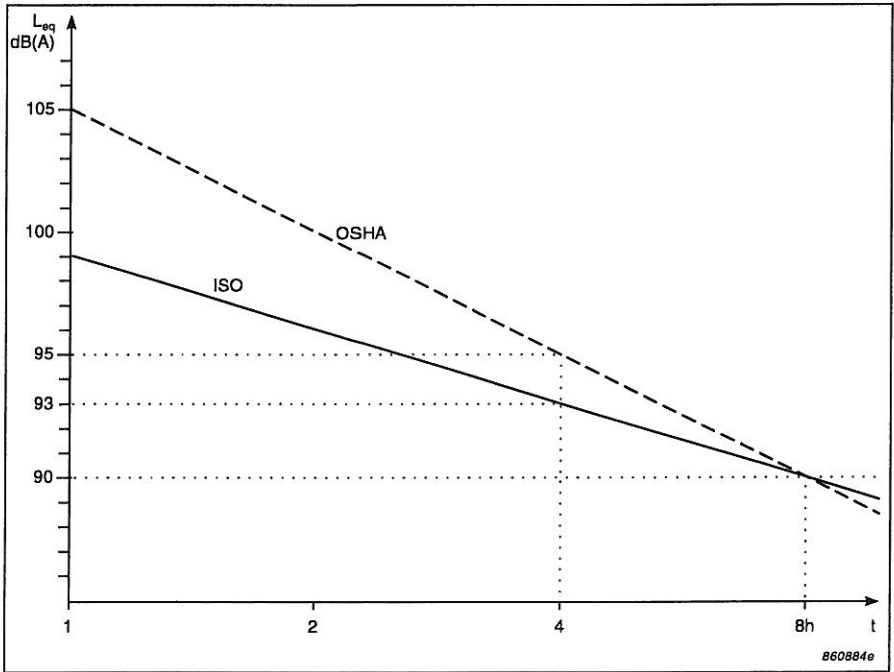

Fig. 10.1 The effect of an Exchange Rate of 3 or 5 dB

Exchange Rate (dB)	Parameter
3	L_{eq} and $L_{ep,d}$ (always measured)
4	$L_{av,4}$ (L_{DOD})
5	$L_{av,5}$ (L_{OSHA})

Table 10.1 The L_{AV} parameter measured by the sound level meter is dependent on the Exchange Rate

10.2 List of Default Parameters

Menu	Set-up Parameter	Default Value
General	Range	30 – 110 dB
	Peaks Over	140 dB
	2nd Exch. Rate	4 dB
Weightings	Bandwidth (Detector 1)	Broad Band
	Freq. Wgt. (Detector 1)	A ("F")
	Weighting (Detector 2)	Peak
Meas. Control	Sequence	Off
Corr. Filters	Sound Incidence	Frontal
	Windscreen Filter	Off
Input/Output	Aux 1	AC Output
	Aux 2	DC Output
Auto Start	Auto Start No.	1
	Owner	None
Occ. Health	Exposure Time	7:30 (2700 s)
	Criterion	100 dB
	Threshold	0 dB
Save Setup	Save in No.	1
Recall Setup	Recall From No.	Default
Interface	Baud Rate (printer)	9600
	Handshake (printer)	XON/XOFF
	Baud Rate (remote)	9600
Language		English

Menu	Set-up Parameter	Default Value
Display	Contrast Adjust	2

10.3 Messages and Warnings

If you get a message or warning while using or calibrating your Mediator, then refer to the chart below.

Message	Occurs	Solution
<div style="border: 1px solid black; padding: 5px;"> Performing calibration check Please wait </div>	When a calibration is executed	Wait until the calibration is finished
<div style="border: 1px solid black; padding: 5px;"> Saving Please wait </div>	When a new calibration sensitivity value has been accepted	Wait until the new value has been saved
<div style="border: 1px solid black; padding: 5px;"> Warning Measurement will be reset. Continue? </div>	When a measurement has been in progress for more than 1 minute and you are about to delete the measurement data if you: 1: Change the measurement range. 2: Make changes to the measurement set-up. 3: Make a calibration	Normal situation to avoid deleting the measurement. Press "OK" if measurement data should be deleted or "Cancel" if you want to continue the measurement

Chapter 10 – Appendix 1: General Messages and Warnings

<p>Warning</p> <p>X files needed Y files available Continue anyway</p>	<p>When a measurement sequence is set up and the required number of files for the sequence exceeds the number available in memory</p>	<p>Reduce the number of measurements in the sequence or save some of the files in memory on a PC.</p>
<p>Saving file</p>	<p>When a file is being saved</p>	<p>Wait until the file is saved</p>
<p>Deleting selected file(s) ...</p>	<p>When the selected files are being deleted</p>	<p>Wait until the files have been deleted</p>
<p>Delete selected file(s)?</p>	<p>Before a number of selected files are being deleted</p>	<p>Normal situation to avoid deleting files accidentally. Press "OK" to delete the files or press "Cancel" to skip deleting the files</p>
<p>Deleting all files ...</p>	<p>When "Delete All" has been activated and the files are being deleted</p>	<p>Wait until all the files have been deleted</p>

<p>Delete all files?</p>	<p>Before all files are deleted when "Delete All" has been selected</p>	<p>Normal situation to avoid deleting files accidentally. Press "OK" to delete all files or press "Cancel" to skip deleting all files</p>
<p>No tagged files! To tag files use left or right arrow in the file manager</p>	<p>An operation has been activated that requires that a number of files are tagged</p>	<p>Tag the desired files</p>
<p>Disk summary X kbytes total Y kbytes use Z kbytes free Q files available</p>	<p>When "Disk Summary" in the File Manager has been selected</p>	<p>Shows an overview of disk space and files available</p>
<p>Printing ...</p>	<p>When Print has been selected in the Data Files Window or in the Print Manager. The file name for the file that is being printed is shown in the second line if Print has been selected in the File Manager</p>	<p>Wait until the files are printed or press "Cancel" to stop printing</p>
<p>Cancelling ...</p>	<p>When a print operation is cancelled</p>	<p>Normal situation when a print operation is cancelled</p>

Change application?

When the application module is changed and measurement data has not been saved

Normal situation to avoid losing measurement data. Press "OK" to change application and loose data or press "Cancel" to return to the current application module and save data

10.4 Interface Errors

Message	Description	Number
Header not found	An unknown header was supplied to the Mediator	1
Illegal data type	The current interface message requires a different data type	2
Parameter error	The received interface message was ambiguous	3
Char data not found	An unknown character data was supplied to the Mediator	4
Suffix data not found	An unknown suffix was supplied to the Mediator	5
Nr string too long	The supplied numeric string is too long	6
Nr out of range	The supplied numeric exceeds the legal range for the data type	7
Non-decimal out of range	The supplied binary, octal or hex coded numeric exceeds the legal range for the data type	8

Message	Description	Number
String too long	The supplied string is too long	9
Block data too long	The supplied block data exceeds max length of block	10
Too many parameters	The supplied interface message contains more parameters than allowed	11
Out of memory	System error. Mediator was unable to allocate enough memory to handle the interface message used. Use less complex interface commands	12
Output is cancelled	The response to the previous query message was not read from the Mediator	13
Deadlocked	The Mediator interface is in a deadlock condition caused by input buffer full, parser blocked, response formatter blocked and output buffer full. Avoid this by always reading the response to a query before supplying the Mediator with new interface commands. Switch the Mediator off and on again to exit the deadlocked condition.	14
Unexpected byte	An unexpected byte was detected when something else was expected. For example a space was detected instead of a message terminator	15
Unexpected END detected	An unexpected LF (decimal 10) message terminator was detected. For example a “,” or a “+” followed by LF will cause an interface error 16 because these jobs are not correctly finished	16

Chapter 10 – Appendix 1: General
Interface Errors

Message	Description	Number
Interface overrun	Interface messages were received at a rate faster than the Mediator can process them. This caused an internal input buffer overrun	21
Interface handshake error	An interface handshake error was detected. Reset the Mediator and try again	22
Illegal key number used	An unspecified key number has been selected	
Setup during measurement	The set-up cannot be changed while a measurement is proceeding	
No Filter installed	An octave or 1/3-octave filter has been specified and no filter set is installed	
Autostart not applicable	The specified Auto Start is not allowed. The Auto Start has not been set up with the current application module or the date is out of range	
File write error	An error has occurred while storing data	
Illegal value	The specified value is out of range	
Setup during measurement	Mediator was in measurement mode when you tried to change the set-up. Change to pause mode	23
No filter installed	You tried to set up a measurement parameter that requires the filter set	24
Date out of range	Normally occurs when the date for an Auto Start is not valid	25

Message	Description	Number
Auto Start not applicable	There is an error in the set-up for the specified Auto Start	26
File write error	Will not normally occur. The measurement file is corrupt or the instrument is defect	27
Illegal value	The specified value is not allowed	28

10.5 Error messages

If you get an error message while using or calibrating your Mediator, then refer to the chart below.

Message	Occurs	Solution
Calibration error Unstable input signal	During calibration. For example, if foreign sounds have corrupted the calibration signal or if the calibrator is not switched on.	Make sure you have turned on and fitted the calibrator correctly. Check the calibrator's batteries, and/or move to a quieter location. Alternatively use 114 dB calibration level. If the error persists, then contact your Brüel & Kjær dealer.

Message	Occurs	Solution
Calibration error New sens. exceeds acceptance range ± 1.5 dB	During calibration, if the instrument has dis- covered that the required calibration level is more than ± 1.5 dB from the fac- tory calibration (the "Initial Sens." value).	Return to the Cali- bration Window and enter a calibration level that is within the acceptable range. Make sure you have selected the correct calibra- tion level on your calibrator. If the error persists, then you may need a new factory calibration. Contact your Brüel & Kjær dealer for assistance.
Detector error! See error details in User Manual	The output from both- detectors are com- pared and the difference is outside the acceptable range	Try to calibrate again. If the error message persists your Mediator is faulty and must be repaired. Contact your local Brüel & Kjær dealer
Calibration error! Calibrator level too high	The calibrator level is above the maximum specified dynamic range (Only with an unspecified trans- ducer)	Reduce the calibra- tion level and per- form calibration again
Calibration error! Calibrator level too low	The calibrator level is below the maximum specified dynamic range (Only with an unspecified trans- ducer)	Increase the calibra- tion level and per- form calibration again

Chapter 11

Appendix 2: Interface

11.1	Controlling Mediator via the Serial Interface.....	11-3
	Introduction	11-3
11.2	Formats for Interface Messages	11-4
	Terminology for Interface Messages.....	11-4
	Use of Syntax Diagrams.....	11-6
	General Rules for Constructing an Interface Message .	11-7
	Mnemonic Codes.....	11-8
	Message Terminator.....	11-9
11.3	Types of Data.....	11-9
11.4	Character Data.....	11-10
	Numeric Data	11-10
	String Data	11-12
11.5	Information Protocol.....	11-13
	Introduction	11-13
	Header.....	11-13

11.6	Setting up the PC.....	11 – 15
	Commands	11 – 16
	Bandwidth	11 – 17
	Continue.....	11 – 18
	Error?	11 – 18
	File	11 – 19
	Frequency_Weighting_1	11 – 23
	Frequency_Weighting_2	11 – 25
	Header.....	11 – 26
	Identify?	11 – 26
	Key	11 – 27
	PArAmeter?	11 – 29
	PAUse	11 – 32
	RAnge.....	11 – 32
	REset.....	11 – 34
	SEtup	11 – 34
	STatus?	11 – 39
	SYstem	11 – 40
	Version	11 – 41

11.1 Controlling Mediator via the Serial Interface

11.1.1 Introduction

This chapter describes the operation of the Mediator via its serial interface. It assumes that you are familiar with the manual operation of the sound level meter and have some interface programming experience.

Echo

All characters sent via the interface to Mediator are echoed back to the controller, exactly as entered.

Switching on

To avoid accidentally switching Mediator on, the following procedure must be observed when it is desired to switch the Mediator on via the interface.

- The baud rate and handshake parameters must be set to the same for Mediator and the controller (refer to section 3.1.5)
- The first character that is transmitted will activate the Mediator
- Within a short period (8 to 10 seconds) the Mediator must receive more than 4 additional characters to switch on. If no further characters are received within this period it will not be switched on. Use the Echo facility to verify that the Mediator is switched on. Send a character/command via the interface until the character/command is echoed back.

11.2 Formats for Interface Messages

11.2.1 Terminology for Interface Messages

The data transmitted to and from a Mediator conforms to a subset of the ANSI/IEEE Standard, IEEE 488.2 (1987), “IEEE Standard Codes, Formats, Protocols and Common Commands”.

Data that is transferred to or from a Mediator, via the serial interface, is referred to as a “message”. Two types of message can be sent to the Mediator, “command” and “query” messages. Messages output by the Mediator replying to a query message from a controller are referred to as “response” messages.

Messages to the Mediator

The interface messages are designed according to the ANSI/IEEE Std 488.2 (1987), “IEEE Standard Codes, Formats, Protocols and Common Commands”, allowing for compound messages.

Messages that include both a message header and a message sub-header are called compound headers. In compound headers, the message header is called the header path or the “root” header. Interface messages are constructed in a hierarchy in which some of the messages are “root” messages while other messages are only defined for a specific message header.

It is always legal to fully specify any message header using the (:) and the compound header (header path + sub-header), or “root” header only, if no sub-header is defined for the message in question. However, since the parser will recognize only a “root” header after a program message terminator (<Te> or <LF>), the (:) is not required for the first “root” header.

Some main rules are:

- Interface messages may be joined together using the Program Message Unit Separator (;).
- After a Program Message Terminator (<Te>) the parser recognizes only “root” headers (this is also the case after Power Up).
- After reception of a compound header including a header path and a sub-header, the parser assumes the same header path until it recognizes either a (:) or a <Te>. This allows several sub-headers to be joined together with a (;) using only header path in the first message.

Example:

```
Parameter:LEq?;LMAx?;LMIn?<Te>
```

In this example the `Parameter` command is the “root” header which can be preceded with the optional (:). The `LEq?` command following the (:) is a sub-header which can be succeeded by other sub-headers using the (;) as separator. The “root” header is active until another (:) is used or the <Te> command appears:

```
Parameter:LEq?;LMAx?:Frequency_Weighting_1?:Frequency_Weighting_2?<Te>
```

The (;) following the `LEq?` query is used to join the two interface messages, and the (:) following the `LMAx?` query is required to change the “root” header.

Example:

```
:SETup:N1 10;:SETup:N2 50;:SETup:N3 90<Te>
```

When interface messages are joined together using (;), the “root” header may be omitted for a sequence of interface sub-headers belonging to the same “root” header as shown in the following example:

```
:SETup:N1 10;N2 50;N3 90<Te>
```

Messages from the Mediator

The structure of the response messages returned by the Mediator unit depends on the nature of the query from the controller. The messages are in minimum code (mnemonics) or written in full – see section 11.2.4.

11.2.2 Use of Syntax Diagrams

In this manual, syntax diagrams are used to explain the individual messages. Syntax diagrams use three types of symbol, as illustrated in Fig. 11.1.

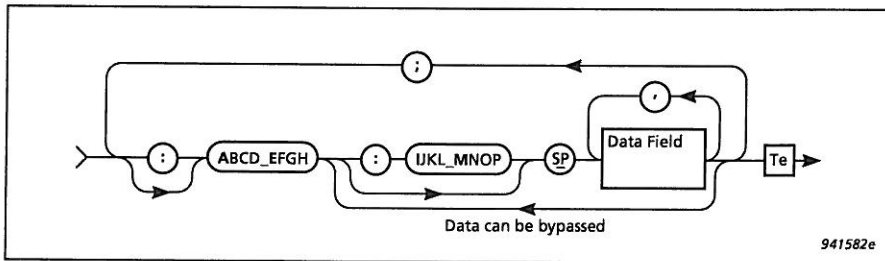

Fig. 11.1 General message syntax

Rectangular symbols indicate that the enclosed data must be replaced by a data item defined elsewhere or chosen by the user. The name of the data item is quoted in the upper left-hand corner of the symbol. The type of the data item, and its allowed length in parentheses are, where appropriate, given in the lower right-hand corner. Circular symbols enclose single character literal data that must be included in the message. Elongated, round-ended symbols indicate literal word data, such as message headers.

Data items that may be by-passed are indicated by lines to and from the main flow line. Data items that **may** be repeated are indicated by lines that loop vertically from the main flow line back over the data item and back to the main flow line. If an item of data **is** repeated, then the number of repetitions

is indicated by a number above the flowline. Flow is from left to right unless arrows indicate otherwise.

11.2.3 General Rules for Constructing an Interface Message

The Mediator allows you to input the message headers and any character type data fields in full. For ease of use, the data field names correspond to those on the Mediator's menu and screen texts wherever possible.

In order to reduce coding and transmission time, mnemonics can be entered for each of the message components which use character type data. The mnemonics are derived from the names of the individual headers or data fields, and their syntax is the same for headers and character type data fields. In this manual a message's minimum allowable mnemonic is given in bold upper case text, for example **Frequency_Weighting_1:F100**. In addition, the following rules apply:

1. All entries can always be written out in full. For example:

```
Frequency_Weighting_1:F100
```

2. Both upper and lower case letters are recognized and are equivalent:

```
frequency_WEIGHTing_1:f100
```

3. All headers and character type data fields can be truncated to the mnemonic.

```
Frequency_Weighting_1:F100
```

```
Freq_Wgt_1:F100
```

```
F_W_1:F100
```

4. All mnemonics are unique and consist of one or more words, with each word consisting of one to three characters, plus the word concatenators (_).

5. When the amplifier receives character type messages, it checks the entire message. Therefore, any mis-spelled words are detected as unknown commands.
6. The amplifier returns the full message or only the mnemonics when transmitting data containing headers and character type data fields over the bus. This is determined by the setting of the parameter **Header** (see section 11.5.2).
7. Between the header and the first data field, a header separator is entered. The header separator is a space (SP).
8. Between each of the data fields, the data separator (a comma <,>) must be entered. See section 11.2.2.

11.2.4 Mnemonic Codes

The following general rules clarify the construction of the mnemonics (minimum codes). The rules apply for all headers and data fields which use character type data.

1. If the first letter of every word produces a unique code, then this is the mnemonic. For example, the header

Frequency_Weighting_1 becomes **F_W_1**

2. If the first letter of every word does not give a unique mnemonic, then include two or more characters of one or more words until the mnemonic is unique. For example, the message

SETUP_SEQUENCE ON becomes **SE_SE ON**
SETUP_SEQUENCE OFF becomes **SE_SE OF**

Notes:

- Word concatenators are always required in mnemonics which include more than one word, except immediately before the question mark (?) in an input message header. Here, the inclusion of the word concatenator is optional.

- In the tables and syntax diagrams throughout this interface manual, the mnemonics are the characters appearing in bold within the headers and character type data fields.
- Headers are output either in full or in mnemonic form by the amplifier.

11.2.5 Message Terminator

The only legal Program Message Terminator character is the NL (line feed – decimal 10). The <Te> is considered to be a LF.

11.3 Types of Data

A message can contain one or more data fields, or none. The type of allowed data varies for each message, but the available types are:

- character data
- numeric data (decimal and integer)
- string data

The data separator used between all data fields is a comma (,). Fig. Fig. 11.2 shows the general syntax of a message containing all legal data types.

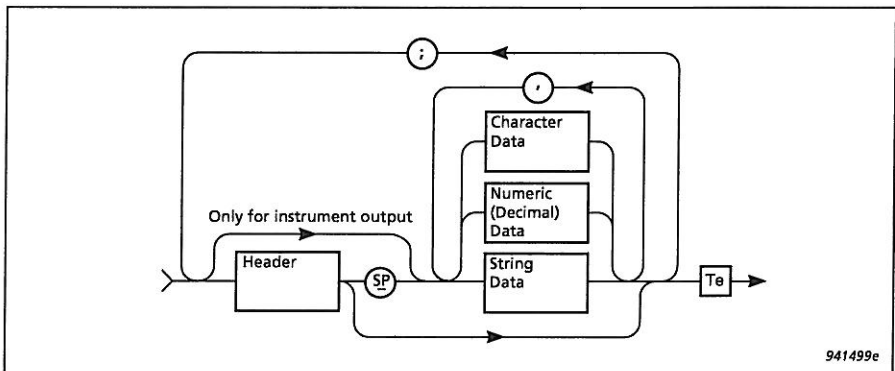

11.4 Character Data

Character data must begin with an alphabetic character, either upper or lower case. This initial alphabetic character can be followed by any printable ASCII character (from 32 through 127 (decimal)), with the exception of a space (SP), a comma (,), a semi-colon (;), a colon (:), or the delete character (DEL). Fig.11.3 shows the valid form of entry for character data.

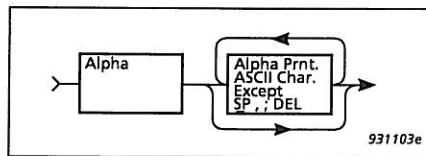

Fig.11.3 General syntax for character data fields

All headers and set-up parameter names are character data, as are many of the parameter settings. In the syntax diagrams, character data is represented by “Char.”. When character data **must** be included, the data is written out in full in the syntax diagrams with the mnemonic codes marked as bold upper-case characters.

11.4.1 Numeric Data

Numeric data that is entered through the interface closely follows the format defined in the ANSI/IEEE 488.2 (1987) Standard, “IEEE Standard Codes, Formats, Protocols and Common Commands” and the ISO 6093–1985 Standard, “Representation of numerical values in character strings for information interchange”.

The types of numeric data are represented in the syntax diagrams by NR1, NR2 and NR3, conforming to the above mentioned standards. The data is checked for illegal numbers not conforming to the above standards. The syntax for NR1 data (implicit point representation) is shown in Fig.11.4 .

NR2 data (floating point number with an explicit decimal point) is not represented below as it is included in NR3. Mediator usually accepts the full NR3 (explicit point scaled representation, see Fig. 11.5), except where syntax diagrams state that NR1 or NR2 is required.

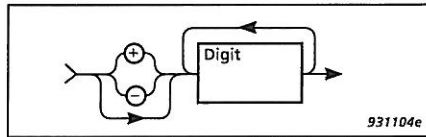

Fig. 11.4 Syntax for numerical data of type NR1

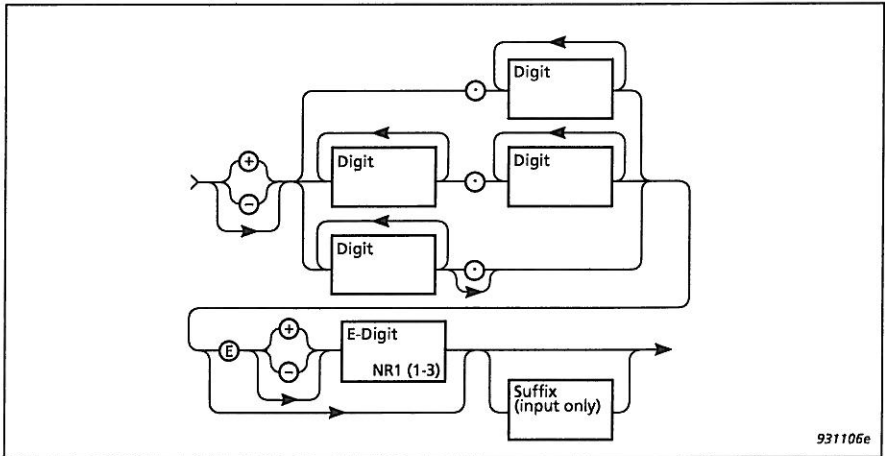

Fig. 11.5 Syntax for numerical data of type NR3

A digit is any of the 10 number symbols, 0 through 9.

In this manual both commands and queries are illustrated using syntax diagrams, and are usually accompanied by examples. When a syntax diagram illustrates the input of numeric data, an explanation is given as to how the Mediator accepts the numeric data. A legal range is always given (unless only specific values are allowed, and these are shown),

and the value received by the amplifier is rounded so that it lies within the allowable range.

If many values are legal, the explanation given will indicate whether Mediator chooses the nearest value above (Round Up) the nearest value below (Round Down) or just the nearest value (Round Nearest). The value is always rounded to the given resolution.

The default value for the parameter is also given. This is the factory setting for that parameter.

11.4.2 String Data

String data is the format used to enter text in a message. In addition, it is used to enter special characters not allowed in character data fields.

String data is always enclosed in quotation marks. To include one quotation mark in the string data field, two quotation marks need to be entered. Fig. 11.6 gives the syntax for entering string data. The length in characters of a fixed length string data is given in parentheses after the data type name.

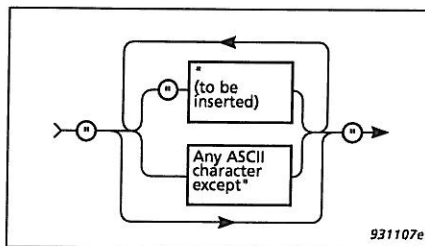

Fig. 11.6 Syntax for entering string data

Example:

"This is the text."

"This text contains \" \" one quotation mark."

11.5 Information Protocol

11.5.1 Introduction

Each command or query described in this manual has a name, or Header. The header can be thought of as a variable name, and the value or option it is assigned is the parameter value which the Mediator actually uses to carry out the specified operation. See Fig.11.7.

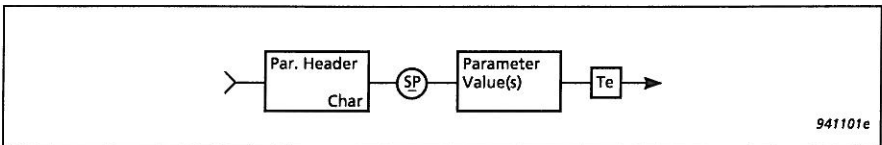

941101e

Fig.11.7 The header designates the parameter name for the value (or option) which follows

11.5.2 Header

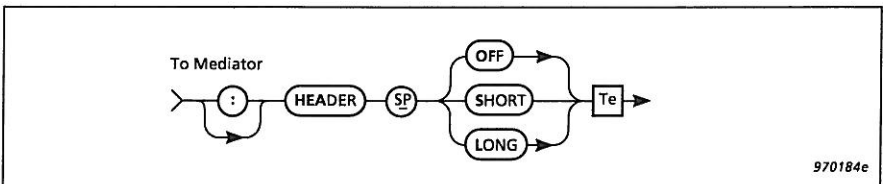

970184e

Fig.11.8 Syntax for Header command

The **Header** command allows you to specify how the response messages are to be sent from the Mediator:

OFF If you specify **OFF**, no header will be returned to you by the amplifier as a query response.

- Short** If you specify **Short** as the header, character data from the amplifier will be sent as mnemonics. That is, the letters shown in bold only for each command.
- Long** If you specify a **Long** header, the Mediator will return the entire name for each command header and character data.

Example of a response with a **Long** header to the query:
Bandwidth?

:BANDWIDTH OCTAVE_3

Example of the response with a **Short** header to query:
Bandwidth?

:B O_3

Example of the response with an **Off** header to the query:
Bandwidth?

O_3

You can query Mediator regarding the header setting as shown in Fig. 11.9.

The default setting is **Long**

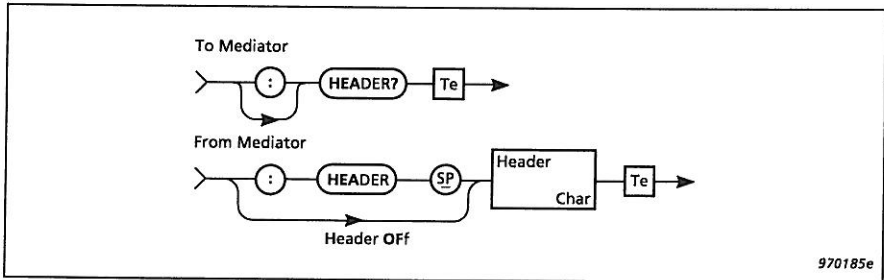

Fig. 11.9 Syntax for Header? query and Mediator response

Example Response:

```
:Header Long  
:H S  
OF
```

11.6 Setting up the PC

Warning! When connecting Mediator to a PC, ensure that both the computer and the Mediator are switched off. Otherwise the instruments could be damaged.

1. Connect the computer to Mediator via the **SerialInterface** socket on the base of the Mediator using 9-pole Cable with 25-pole Adaptor AO 1386. If the computer has a 9-pole interface socket, remove the adaptor.
2. Start a communications program (e.g. BK-Link or ProComm) on the computer.

Refer to section 7.2 for Brüel & Kjær software such as Noise Explorer™ 7815, Protector™ 7825 and Evaluator™ 7820/7821, which are written specifically for communicating with your sound level meter, working with and displaying sound level meter data.

3. Configure the computer as follows (depending on the communications program):

```
9600 Baud  
8 data bits  
1 stop bit  
Parity: none  
Handshake: Hardwired
```

4. Switch on Mediator via the interface.
5. Set the Mediator's Baud Rate to 9600 and Handshake to Hardwired (see section 3.1.5). for the remote interface.

6. Press **(Enter)** on the computer.

Communication is established and the prompt (>) is shown on the computer screen. The Mediator can now be controlled from the computer.

Note: The baud rates and handshake of the Mediator and the computer must be the same to enable them to communicate without losing or corrupting data. A higher baud rate may be possible depending on your system.

11.6.1 Commands

The command and query messages available are listed in Table 11.1. The commands and queries are explained in the following sections, in alphabetical order.

Message	Command	Query	Message	Command	Query
Bandwidth	•	•	PAparameter		•
Continue	•		PAUse	•	
Error		•	RAngle	•	•
File		•	REset	•	
Frequency_Weighting_1	•	•	SEtup	•	•
Frequency_Weighting_2	•	•	STatus		•
Header	•	•	SYstem	•	•
IDentify		•	Version		•
Key	•				

Table 11.1 Command and query message overview

11.6.2 Bandwidth

The **Bandwidth** command is used for setting the bandwidth for Detector 1. The syntax is shown in Fig. 11.10.

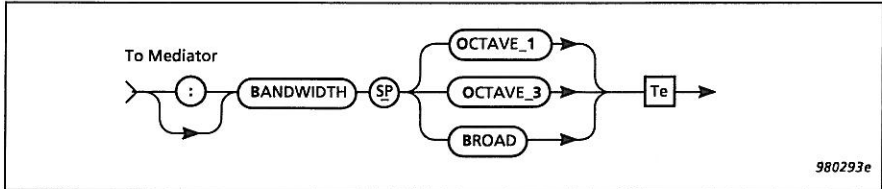

*Fig. 11.10 Syntax for **Bandwidth** command*

The default setting is: Broad band

Note: The $1/3$ - and $1/1$ -octave options are only available when the $1/1$ -octave and $1/3$ -octave Filter Set is installed in the Mediator.

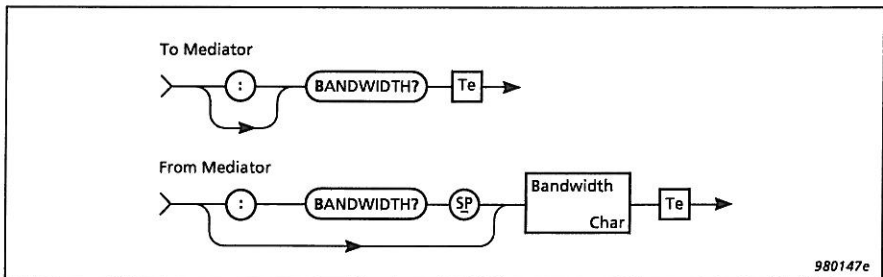

*Fig. 11.11 Syntax for the **Bandwidth?** query and Mediator response*

The syntax for the query **Bandwidth?** and the response returned by the Mediator appears in Fig. 11.11.

Example (setting the bandwidth to 1/3 octave):

Interface job from controller:

Bandwidth **Octave_3**

Query from controller:

Bandwidth?

From Mediator:

:Bandwidth Octave_3

11.6.3 Continue

The Continue command starts a measurement without resetting the mediator. The syntax is shown in Fig. 11.12.

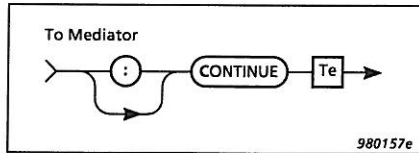

Fig. 11.12 Syntax for Continue command

11.6.4 Error?

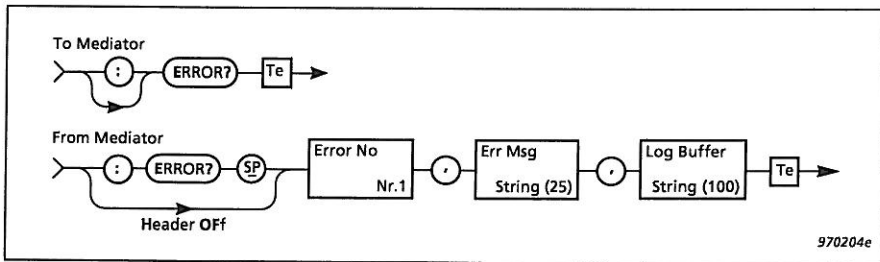

Fig. 11.13 Syntax for Error? query and amplifier response

The Error? query returns information from the Mediator about the error condition of the device, where “Error No” is the number of the error, “Err Msg” is a string containing a short description of the error, and “Log Buffer” contains a

string with the interface message which was executing when the error occurred. If the error was a device error, the log buffer will be empty.

After the response to the **ERror?** query is sent, the error buffer is reset and Error No is set to 0. See section 10.4 for a detailed listing of all interface and device errors.

Example:

Query from controller:

Error?

From Mediator:

:Error 16, "UNEXPECTED END DETECTED ", "^10^END

11.6.5 File

The **File** queries are used for performing operations on the files in the Mediator memory.

Files are numbered from 0 to 512 for each software package. File number 0 is only used for back-up purposes, so that the total number of files is 511. File names normally consist of three characters with a three character extension, however, the file name may contain up to 8 characters.

Copy? query

Copy? is used for getting one or more files from the Mediator File Manager. You can specify a block of files by using the "*" and "?" wild card characters. The syntax for the **Copy?** query is shown in Fig. 11.14.

The first figure in the block size descriptor specifies how many figures follow, these figures specify the size of the binary data block.

Example (copying file 21 from the Basic software package):

Interface job from controller:

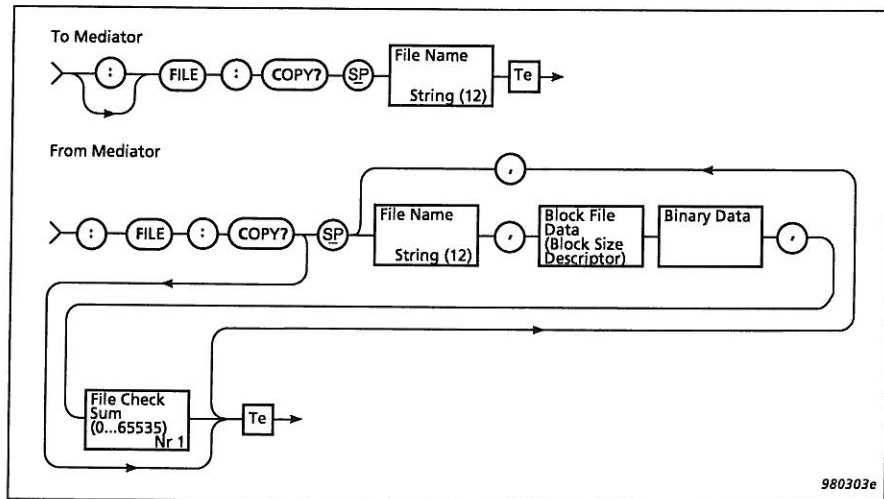

Fig. 11.14 Syntax for the File:Copy command

File:Copy? "021.M26"

From Mediator:

:FILE:COPY "021.M26",#3409 (binary data)

Delete? query

DElete? is used for deleting one or more files from the Mediator File Manager. You can specify a block of files by using the "*" and "?" wild card characters. The syntax for the **DElete?** query is shown in Fig. 11.15.

The response to a **DElete?** query is a **File_Ok** or **File_Failed** message from the Mediator.

Example (deleting all files from the Basic software module):

Interface job from controller:

File:Delete? "* .M26"

From Mediator:

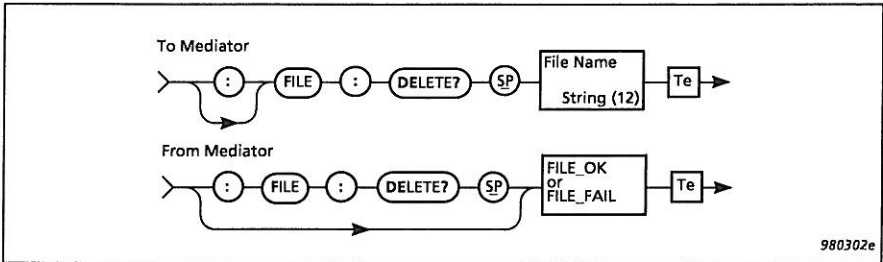

Fig. 11.15 Syntax for the **File:DElete** command

```
:FILE:DELETE FILE_OK
```

Directory? Query

The **File_DIrectory?** query shows the entire contents of the Mediator File Manager or you can specify the file names you want to see. The directory string shows the number of files, the file names and the associated file information, i.e., day, month, year, hour, minute and second. The syntax for the **File_DIrectory?** query and response returned by the Mediator appear in Fig. 11.16.

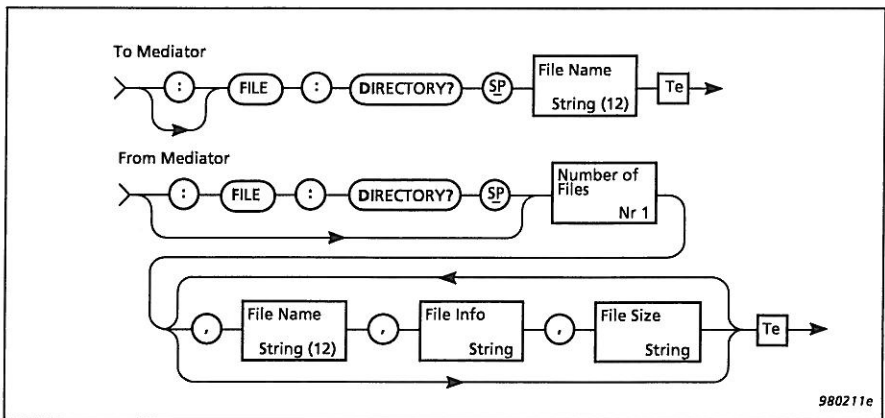

Fig. 11.16 Syntax for the **File_DIrectory?** query and Mediator response

Example (show all files with extension M26):

Interface job from controller:

File:DIrectory? "*.M26"

From Mediator:

```
:FILE:DIRECTORY 7, "MEASPAR.M26", "1998-07-23  
09:57:30", "468", "SETUP_0.M26", "1998-07-23  
09:30:58", "115", "SETUP_1.M26", "1998-07-23  
09:30:58", "115", "SETUP_2.M26", "1998-07-23  
09:30:58", "115", "SETUP_3.M26", "1998-07-23  
09:30:58", "115", "SETUP_4.M26", "1998-07-23  
09:30:58", "115", "001.M26", "1998-07-23 10:13:46", "409"
```

Space? Query

The **File_Space?** query shows how much memory space remains in the Mediator memory. The syntax for the **File_Space?** query and response returned by the Mediator appear in Fig. 11.17.

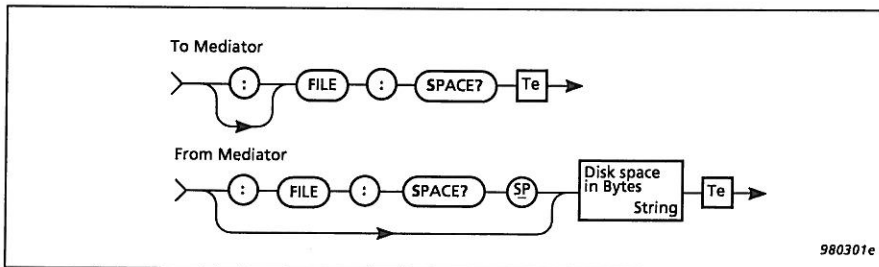

Fig. 11.17 Syntax for the **File_Space?** query and Mediator response

Example (space query):

Interface job from controller:

File:Space?

From Mediator:

```
:FILE:SPACE? "2011648"
```

Save? query

SAve? is used for storing the current measurement file (refer to section 6.1.1 for information about saved data). The file is saved with a file number and an extension that identifies the current software module, for example, **005.M26**. The syntax for the **SAve?** query is shown in Fig. 11.18.

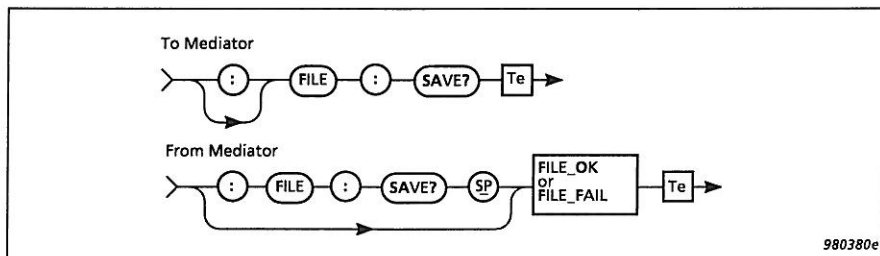

Fig.11.18 Syntax for the File:SAve command

The response to a **SAve?** query is a **File_Ok** or **File_Failed** message from Mediator. The **File_Failed** message will normally only occur if there is not sufficient memory space.

Example (saving the current measurement file):

Interface job from controller:

```
File:SAve?
```

From Mediator:

```
:FILE:SAVE FILE_OK
```

11.6.6 Frequency_Weighting_1

The **Frequency_Weighting_1** command is used for setting up the frequency weighting options for Detector 1. The syntax is shown in Fig. 11.19.

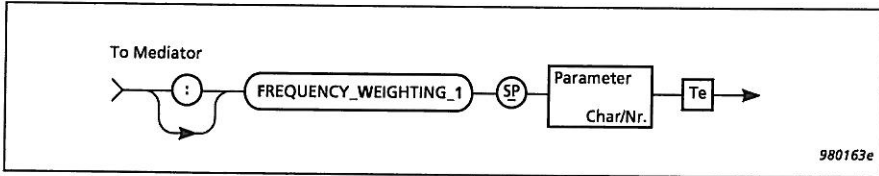

Fig. 11.19 Syntax for `Frequency_Weighting_1` command

The default setting is: A-weighting

The frequency weighting values are: A, C, Lin, F20, F25, F31_5, F40, F50, F63, F80, F100, F125, F160, F200, F250, F315, F400, F500, F630, F800, F1K, F1K25, F1K6, F2K, F2K5, F3K15, F4K, F5K, F6K3, F8K, F10K, F12K5.

Note 1: The “K” is used as decimal separator.

Note 2: Some combinations of weightings are mutually exclusive for the two detectors.

The syntax for the query `Frequency_Weighting_1?` and the response returned by the Mediator appears in Fig. 11.20.

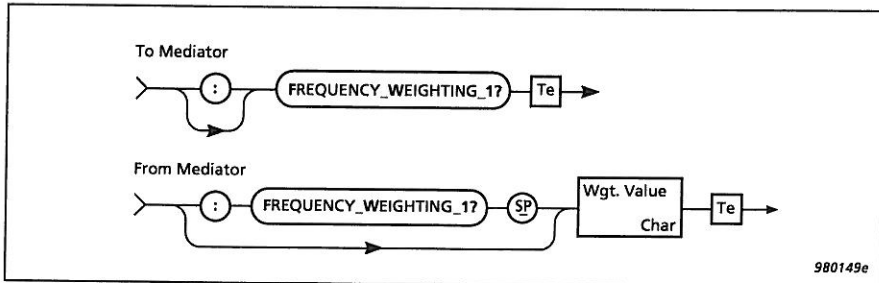

Fig. 11.20 Syntax for the `Frequency_Weighting_1?` query and Mediator response

Example (setting frequency weighting for Detector 1 to C-weighting):

Interface job from controller:

Frequency_Weighting_1 C

Query from controller:

Frequency_Weighting_1?

From Mediator:

:FREQUENCY_WEIGHTING_1 C

11.6.7 Frequency_Weighting_2

The **Frequency_Weighting_2** command is used for setting up the frequency weighting options for Detector 2. The syntax is shown in Fig. 11.21.

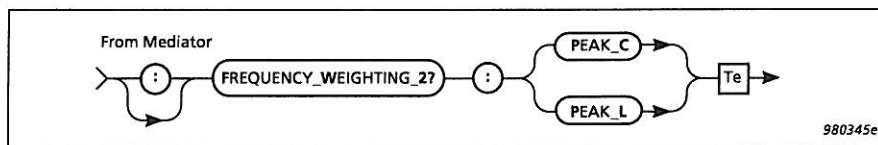

Fig. 11.21 Syntax for Freq_Wgt_2 command

The default setting is: Peak and C-weighting

Peak weighting can be C or L.

The syntax for the query **Frequency_Weighting_2?** and the response returned by the Mediator appears in Fig. 11.22.

Example (setting frequency weighting for Detector 2 to Peak and L-weighting):

Interface job from controller:

Frequency_Weighting_2 Peak_L

Query from controller:

Frequency_Weighting_2?

From Mediator:

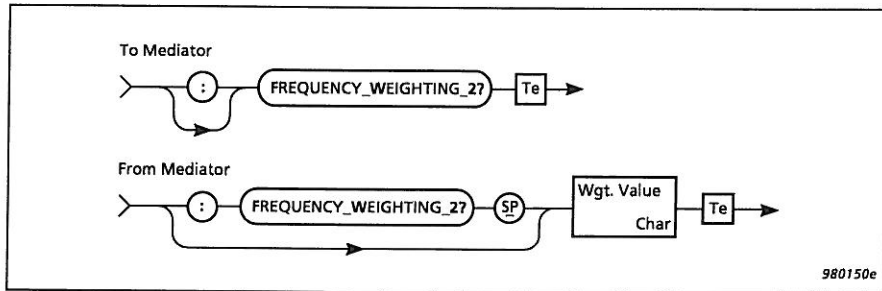

Fig. 11.22 Syntax for the `Frequency_Weighting_2?` query and Mediator response

`:FREQUENCY_WEIGHTING_2 PEAK_L`

11.6.8 Header

Refer to section 11.5.2.

11.6.9 Identify?

The `Identify?` query returns the device ID, which for the Mediator is “B&K 2238”. This is a standard Brüel & Kjær method of determining which device is currently connected via the interface. The syntax for the `Identify?` query is shown in Fig. 11.23.

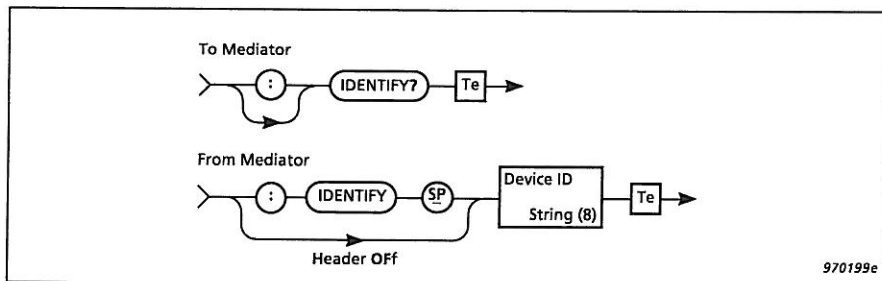

Fig. 11.23 Syntax for the `Identify?` query and Mediator response

Example:

Query from controller:

Identify?

From Mediator:

:IDENTIFY "BK2238"

11.6.10 Key

The **Key** command allows you to use the pushkey functions via the interface. See section 2.3 for a description of pushkey functionality. The 16 keys on the front panel are numbered according to Fig. 11.24.

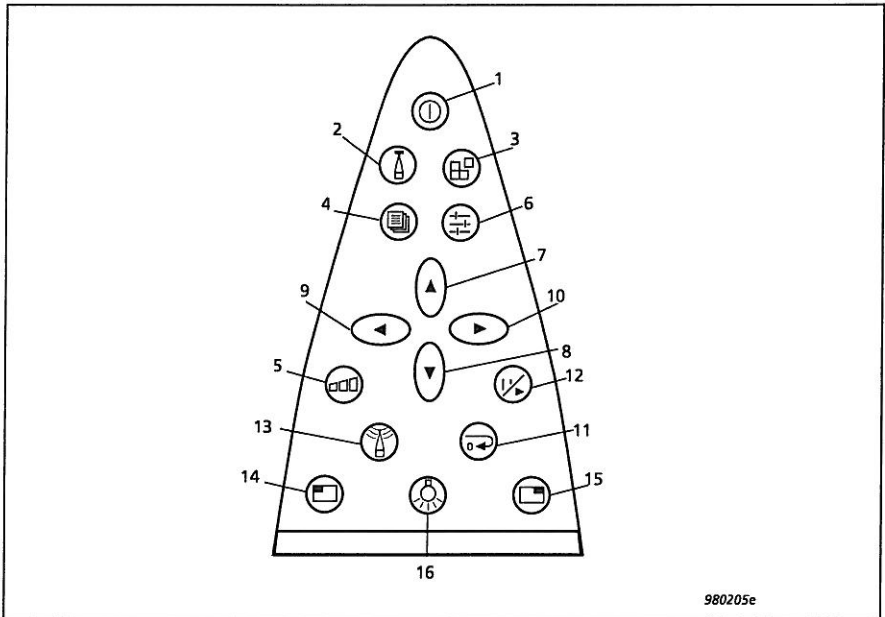

Fig. 11.24 Numbering of keys on the front panel

You may use the key numbers shown in Fig. 11.24 or the key names used in the syntax diagram in Fig. 11.25.

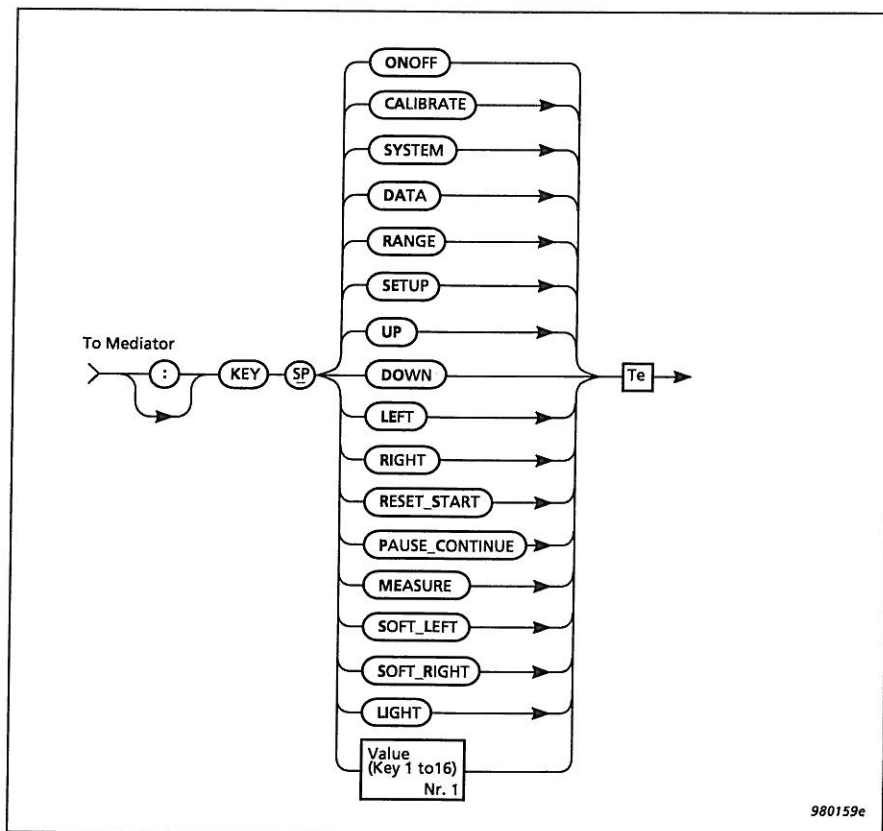

Fig. 11.25 Syntax for the Key command

Note: An interface error may occur if a key command sequence is used for recalling one of the four user defined setups or the factory set-up or if you try to change the interface parameters in the Remote Interface Window. This is because these commands reset the interface to set up the new interface parameters.

Example (key sequence for stepping the measurement range 10 dB up):

Interface job from controller:

Key 5<Te>
Key 10<Te>
Key 14<Te>
Key 14<Te>

Alternatively:

Key RAnge<Te>
Key RAnge<Te>
Key Soft_Left<Te>

Note: When you use a “manual” key sequence command you must normally ensure that the cursor is in a known position, for example by sending the Key MEasure<Te> and Key Soft_Right<Te> commands immediate before the key sequence.

11.6.11 PArAmeter?

The PArAmeter? query is used for checking the selected measurement parameters. The syntax for the query PArAmeter? and the response returned by the Mediator appears in Fig. 11.26.

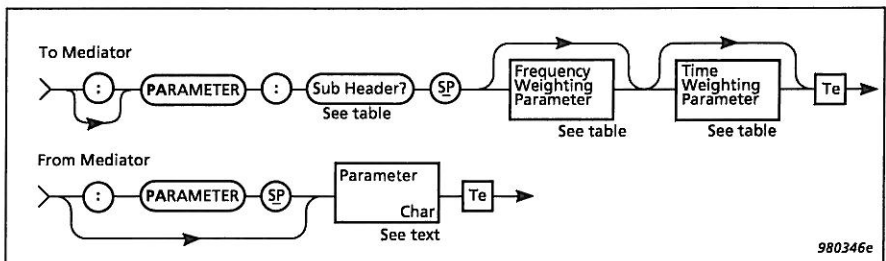

Fig. 11.26 Syntax for the PArAmeter? query and Mediator response

Sub Header	Frequency Weighting Setting	Time Weighting Setting
Aux_1	—	—
Aux_2	—	—
Dose	—	—
Dose_Lav	—	Fast Slow
EAd	—	—
ED	—	—
ELapsed	—	—
Inst	A C Lin Octave	Fast Slow Impulse
LAv	A C Lin Octave	Fast Slow
LEq	A C Lin Octave	—
LEPd	—	—
Lleq	A C Lin Octave	—

Table 11.2 Sub-header and parameter settings for the PArameter? query

Sub Header	Frequency Weighting Setting	Time Weighting Setting
LMAx	A C Lin Octave	Fast Slow Impulse
LMIIn	A C Lin Octave	Fast Slow Impulse
LP	A C Lin Octave	Fast Slow Impulse
LPK	—	—
LPKMax	—	—
No_Peaks	—	—
Overload	—	—
Underrange	—	—

Table 11.2 Cont.Sub-header and parameter settings for the PAMeter? query

Example (reading the measured L_{Aeq} value):

Query from controller:

Parameter:LEq? A

From Mediator (value in dB):

:PARAMETER_LEQ 46.9

11.6.12 PAUse

The **PAUse** command message puts the Mediator in Pause mode. The pause will take effect on the next even second of the Mediator's clock. Therefore, you must wait for one full second before sending the next command to be sure that the pause condition is in effect.

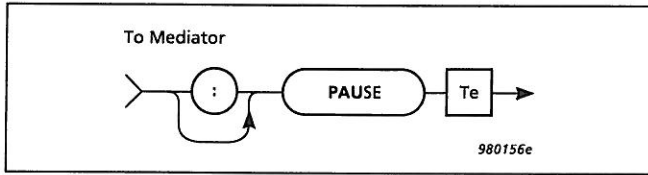

Fig. 11.27 Syntax for the **PAUse** command

11.6.13 RAnge

The **RAnge** command message is used for setting the measurement range.

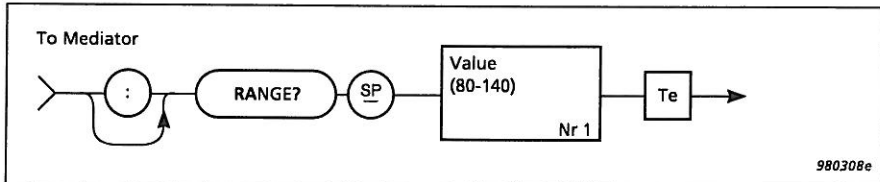

Fig. 11.28 Syntax for the **RAnge** command

The default range setting is: 30 – 110 dB

You must enter the Value field as the upper value in the desired measurement range. Table 11.3 lists the default field settings.

Field Name	Field Setting	Comments
Value (command)	80	0 – 80
	90	10 – 90
	100	20 – 100
	110	30 – 110
	120	40 – 120
	130	50 – 130
	140	60 – 140
Status (query response)	0 – 80	These are the default ranges. However, if a non-standard transducer is used the ranges may be different.
	10 – 90	
	20 – 100	
	30 – 110	
	40 – 120	
	50 – 130	
60 – 140		

Table 11.3 **R**ANge data fields and codes

The **R**ANge? query message shows the current measurement range. The syntax for the query and the response returned by the Mediator appears in Fig. 11.29.

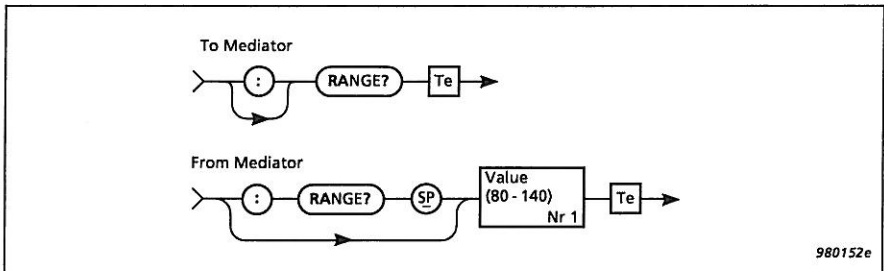

Fig. 11.29 Syntax for the **R**ANge? query message and Mediator response

Example (setting the measurement range to 50–130 dB):

Interface job from controller:

RAnge 130

Query from controller:

RAnge?

From Mediator:

:RANGE 130

11.6.14 REset

The **RE**set command message resets the Mediator. The measurement is restarted, i.e., the current measurement data is deleted and the buffer and the Elapsed Time parameter are set to zero. This command is equivalent to pressing the ↵ key.

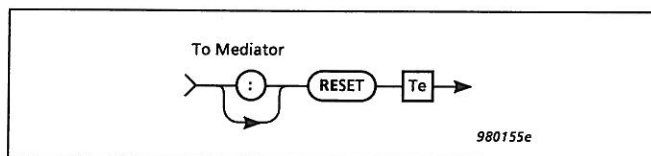

Fig. 11.30 Syntax for the REset command

Note: There is no reset warning.

11.6.15 SEtup

The **SE**tup commands are used for setting up most of the measurement parameters in the Measurement Setting menu. A separate sub-header is used for the Auto Start commands, to distinguish the four possible Auto Start sequences.

Auto Start Command

The syntax for the **Auto_Start_X** command is shown in Fig. 11.31.

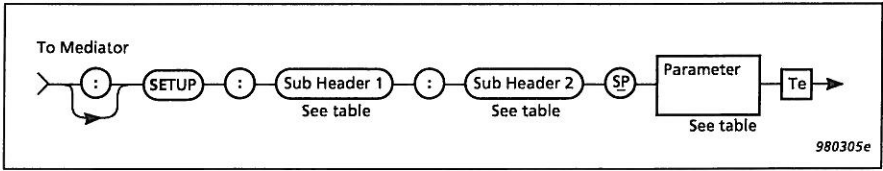

Fig. 11.31 Syntax for the *SETup:Auto_Start_X* command

Sub Header 1	Sub Header 2	Parameter Setting	
Auto_Start_1 Auto_Start_2 Auto_Start_3 Auto_Start_4	Application	Current_Bz None	Char.
	Setup_No	1 ... 4	NR1
	Time	(Year) –3000 ... 3000 (Month) 1 ... 12 (Day) 1 ... 31 (Hour) 0 ... 23 (Minute) 0 ... 59 (Second) 0 ... 59	NR1

Table 11.4 *Auto_Start_X* sub-header and parameter settings

Example (setting the owner for Auto Start number 3 to the current application module):

Interface job from controller:

SETup:Auto_Start_3:Application Current_Bz

Query from controller:

SETup:Auto_Start_3?

From Mediator:

:SETUP:AUTO_START_3
1998,7,23,11,13,27,"BZ7126",1

Other SETup Commands

The remaining SETup commands use the syntax illustrated in Fig. 11.32.

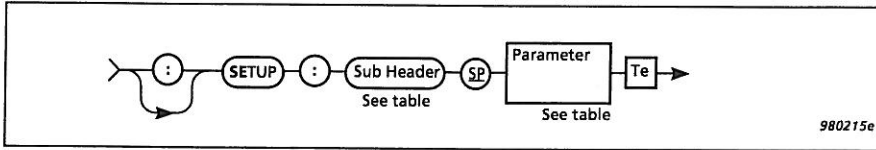

Fig. 11.32 Syntax for the SETup command

Sub Header	Parameter Setting		Comments
Aux_1_FW	LINEar_Frequency_Weighting Detector_1_Frequency_Weighting	Char	Sets Linear Frequency weighting or Detector 1 output to the Aux 1 output
Criterion_Level	70 ... 100	NR3	Sets Criterion level between 70 and 100 dB
Exchange_Rate	4, 5	NR1	Sets Exchange Rate to 4 or 5 dB
Exposure_Time	(Hour) 0 ... 23 (Minute) 0 ... 59	NR1	Sets Exposure Time in hours and minutes
Peaks_Over	0 ... 180	NR3	Sets the peak counting level
PREset_Time	(Hour) 0 ... 9999 (Minute) 0 ... 59 (Second) 0 ... 59	NR1	Sets the measurement time for each measurement in an Auto Start sequence
Random_Frontal	Random Frontal	Char	Sets Random or Frontal frequency correction
Recall	0 ... 4	NR1	Recall measurement set-up 0 to 4 (0 is default set-up)

Table 11.5 Sub-header and parameter settings for the SETup command

Sub Header	Parameter Setting		Comments
SAve	1 ... 4	NR1	Saves measurement set-up in memory 1 to 4
SEquence	OFF, ON	Char	Switches the Auto Start sequence On or Off
Threshold_Level	0 ... 100	NR3	Sets the Threshold level in dB for Occupational Health
Wind_Screen	OFF, ON	Char	Switches the windscreen frequency correction On or Off

*Table 11.5 Sub-header and parameter settings for the **SEtup** command*

The syntax for the query **SEtup?** and the response returned by Mediator appears in Fig. 11.33.

Sub Header
Auto_Start_1? Auto_Start_2? Auto_Start_3? Auto_Start_4?
Aux_1?
Aux_1_FW?
Aux_2?
Criterion_Level?
Exchange_Rate?
Exposure_Time?
Peaks_Over?
Preset_Time?
Random_Frontal?
SEquence?
Threshold_Level?
Wind_Screen?

Table 11.6 SEtup queries

Example (checking the Preset Time set to 10 minutes):

Query from controller:

SEtup:Preset_Time?

From Mediator:

:SETUP:PRESET_TIME 0,10,0

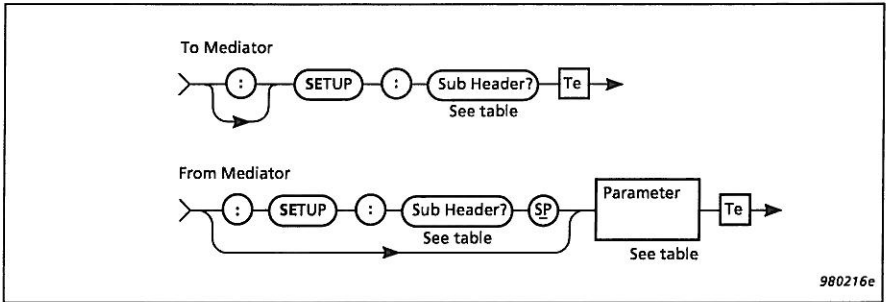

Fig. 11.33 Syntax for the **SETUP?** query and Mediator response

11.6.16 **STatus?**

The **STatus?** query is used to check whether the Mediator is in pause mode or is measuring. The syntax is shown in Fig. 11.34.

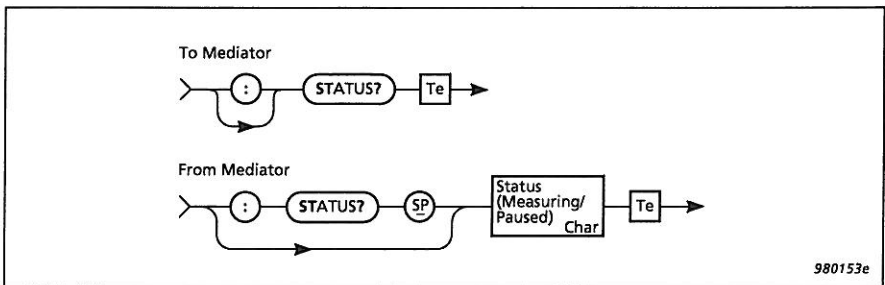

Fig. 11.34 Syntax for the **STatus?** query and Mediator response

The status can be: Measuring or Paused

Example:

Query from controller:

STatus?

From Mediator:

:STATUS PAUSED

11.6.17 SYstem

The **SY**stem command is used for setting the date and time on the Mediator's calendar and clock. The syntax is shown in Fig. 11.35.

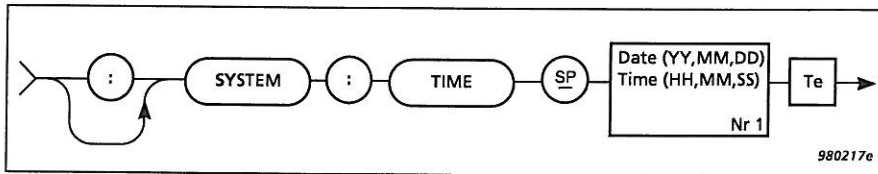

Fig. 11.35 Syntax for SYstem commands

Sub Header	Date and Time Setting		Comments
Time	(Year) -3000 ... 3000 (Month) 1 ... 12 (Day) 1 ... 31 (Hour) 0 ... 23 (Minute) 0 ... 59 (Second) 0 ... 59	NR1	Comma separated in the form of: YY,MM,DD,HH,MM,SS

Table 11.7 Parameter settings for the SYstem:Time command

The syntax for the query **SY**stem? and the response returned by the Mediator appears in Fig. 11.36.

Example (setting the time to 1. January 1999, 10:15:00):

Interface job from controller:

SYstem:Time 1999,01,01,10,15,00

Query from controller:

SYstem:Time?

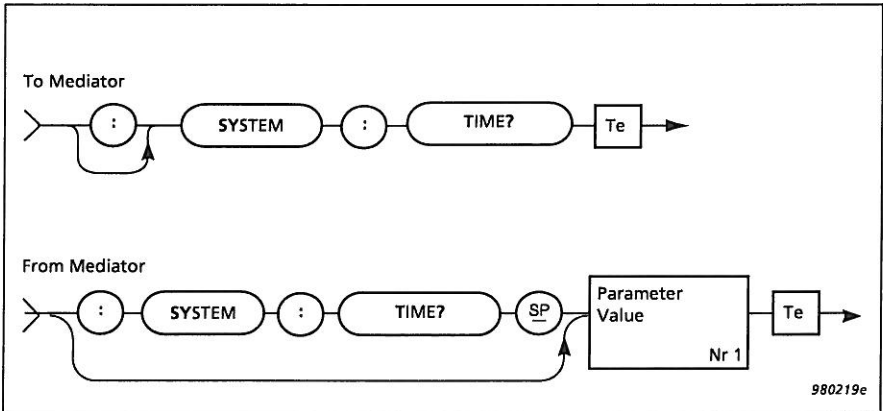

Fig. 11.36 Syntax for the *SYstem?* queries and Mediator response

From Mediator:

:SYSTEM:TIME 1999,01,01,10,15,00

11.6.18 Version

The *Version?* query message shows the running software version of the Mediator. The Syntax is shown in Fig. 11.37.

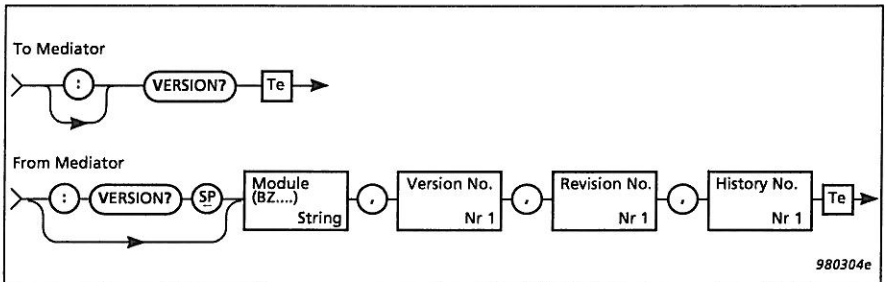

Fig. 11.37 Syntax for the *Version?* query message and Mediator response

Field Name	Field Setting	Comments
Version status	BZ 7126 BZ 7125 BZ 7123 BZ 7124	Basic SLM Software Enhanced SLM Software Frequency Analysis Software Logging SLM Software

Table 11.8 Version data fields and codes

Example (checking the current version):

Query from controller:

Version?

From Mediator:

:VERSION "BZ7126",1,0,0

Chapter 12

Index

Numerics

- 1/1-octave and 1/3-octave filter set 1-5
- 9-pole cable 1-4, 7-5, 11-15

A

- About System Window 3-8
- AC Output 7-6
- Accessories (effect of) 9-5
- Application
 - module 1-7, 3-4
 - programs 1-5, 2-8, 7-5
 - status 4-10
 - Window 3-4
- ASCII characters 11-10
- Auto Start 4-9, 5-10, 6-2
 - application status 4-10
 - sequence 4-10
 - Window 4-9
- Auto_Start_1...4 command 11-35
- Auto_Start_1..4? query 11-38
- Aux 1 1-5, 4-8, 9-4
- Aux 2 1-5, 4-8, 9-4
- Aux_1? query 11-38
- Aux_1_FW command 11-36
- Aux_1_FW? query 11-38
- Aux_2? query 11-38
- A-weighting 1-5

B

- Backlight 1-14, 2-10
- pushkey 2-10

- Back-up battery 1-13, 2-4
- Bandwidth 5-10
 - command 11-17
- Bar graph 2-10, 4-4, 5-11
- Basic
 - configuration 1-4
 - SLM software 1-4, 1-7
 - version (BZ 7126) 1-3
- Batteries 6-2, 8-3, 9-4, 9-5
 - checking level 2-2
 - fitting 2-2
 - handling 2-3
 - operating time 2-3
 - recharging 2-3
 - saving 2-10
 - type 1-4
- Battery
 - back-up 1-13, 2-4
 - flat 2-4
 - level 2-12
 - remaining time 2-3
 - symbol 2-2
- Baud rate 3-5, 7-3, 7-4, 11-15
- Broadband data 1-14, 6-3, 6-4
- Buffer 1-13, 6-2, 11-34

C

- Calendar data 1-12
- Calibrate pushkey 2-8
- Calibration 5-2
 - data 1-12

- factor1-13
- Free-field/Diffuse Field5-2
- history1-12
- menu1-10, 1-12
- principle of5-2
- set-up1-13, 6-3
- signal5-2
- time6-3
- when to5-2
- Window5-2
- Calibrator
 - types5-3
- Cancel pushkey2-10
- Care of Mediator8-2
- Centre frequency5-10
- Changing
 - applications1-7
 - displayed parameter5-11
 - language2-12
- Character data11-9, 11-10
- Checking
 - battery level2-2
 - calibration5-7
- Cleaning Mediator8-2
- COM port7-5
- Command
 - Auto_Start_1..411-35
 - Aux_1_FW11-36
 - Bandwidth11-17
 - Continue11-18
 - Criterion_Level11-36
 - Exchange_Rate11-36
 - Exposure_Time11-36
 - File11-19
 - Frequency_Weighting_111-23
 - Frequency_Weighting_211-25
 - Key11-27
 - PAUse11-32
 - Peaks_Over11-36
 - Preset_Time11-36
 - Random_Frontal11-36
 - RAnge11-32
 - Recall11-36
 - REset11-34
 - SAve11-37
 - SEquence11-37
 - SEtup11-34
 - SYStem11-40
 - Threshold_Level11-37
 - Wind_Screen11-37
- Command message overview11-16
- Communication
 - error7-5
 - program11-15
- Compound message11-4
- Computer (setting up)11-15
- Concatenator11-8
- Condenser microphone1-4, 5-3, 9-2
- Connecting a microphone extension cable ...2-7
- Connectors1-5
- Constructing interface message11-7
- Continue command11-18
- Contrast3-7
- Controlling Mediator via the interface11-3
- Conventions in this Manual1-3
- Correction filters1-5, 4-7, 5-2
- Creterion_Level command11-36
- Criterion level4-12
- Criterion_Level? query11-38
- Cursor keys2-9, 3-2, 4-2
- C-weighting1-5
- D**
- D/A converter1-5
- DAT recorder4-8
- Data
 - files1-10, 1-12, 1-13
 - extension1-13
 - menu2-8, 6-4
 - number of1-13
 - set-up data1-13
 - system6-2
 - Files pushkey2-8, 6-7, 7-3
 - separator11-8
 - types11-9
 - character11-10
 - numeric11-10
 - string11-12
- Date and time
 - information6-2
 - setting3-4
- DC Output4-9, 7-6
- Decimal separator11-24
- Default
 - measurement set-up4-13
 - parameters2-5, 10-4
 - set-up2-5
- Delete
 - all files6-9
 - files6-9
- Detectors .1-5, 2-10, 4-5, 9-3, 11-23, 11-25
 - Peak1-5
 - RMS1-5
 - setting up
 - bandwidth4-5
 - frequency weighting4-5
- Diffuse sound field4-7
- Disk Summary6-9
- Display3-7, 9-4
- Displayed parameters5-11
- Dose
 - levels4-11
 - percentage1-9
- Dose%X1-9
- Dose%XY41-9

- Dose%XY5 1-9
Dynamic range 4-3
- E**
- EA 1-8
Effect of accessories 9-5
Elapsed time 1-9, 6-3
EMC 9-5, 9-6
Enhanced SLM Software 1-6, 3-4
Environmental effects 9-4
Error
 list of interface 10-8
 messages 10-11
Error? query 11-18
Evaluator 7-4, 11-15
Exchange rate 4-4, 4-11, 5-11, 10-2
Exchange_Rate command 11-36
Exchange_Rate? query 11-38
Explicit point scaled representation 11-11
Exposure time 4-11, 10-2
Exposure_Time command 11-36
Exposure_Time? query 11-38
External
 DC supply 9-4
 power socket 2-4
 power supply 2-4
- F**
- Fast (F) 1-5
Field
 parameter 2-12
 value 2-12
File
 delete 6-9
 extension 6-2
 list 6-7, 6-8
 Manager 2-8, 6-4, 6-7
 Options Window 6-8
 names 6-2
 print 6-6, 6-8
 recall 6-8
 size 6-7
 store 6-5
File command 11-19
File_Copy query 11-19
File_DElete query 11-20
File_DIrectory? query 11-21
File_SAve query 11-23
File_Space? query 11-22
Filter set 1-4, 1-7, 4-5, 11-17
Fitting batteries 2-2
Flash RAM 1-13, 2-4
Formats for interface messages 11-4
Frequency
 Analysis Software 1-4, 1-5, 3-4
 response 9-3
 weighting ..1-5, 1-7, 4-5, 4-8, 5-11, 7-6, 9-3
Frequency_Weighting_1 command 11-23
Frequency_Weighting_1? query 11-24
Frequency_Weighting_2 command 11-25
Frequency_Weighting_2? query 11-25
Frontal setting 5-3
- G**
- General
 measurement parameters 4-3
 specifications 9-2
 Window 4-3, 4-11
Getting started 2-2
- H**
- Handshake 3-6, 7-3, 7-4, 11-15
Hardwired 3-6, 11-15
Header
 long 11-14
 path 11-4
 separator 11-8
 short 11-14
How Mediator works 1-4
Hydrophone 5-3
- I**
- Identify? query 11-26
Illegal entry 1-11, 2-12
Implicit point representation 11-10
Impulse (I) 1-5
Indicator range 9-2
Inherent noise 9-2, 9-5
Initial
 calibration parameters 1-13
Input/Output
 function 4-8
 Window 4-8
Instantaneous value 5-11
Interface
 error 10-8, 11-28
 message formats 11-4
 parameters (setting up) 3-5, 7-3
International standards 3-8
- J**
- Joining messages 11-5
- K**
- Key
 command 11-27
 position 11-27

- L**
- Language
 - changing2-12, 9-4
 - setting up3-7
 - Latched overload2-11
 - LAV4-11, 10-2
 - LAV510-2
 - LCD screen3-7
 - LDOD4-5
 - Left/Right Arrow pushkey2-9
 - Light (backlight)1-14
 - Linear weighting1-5
 - Logging SLM Software1-5, 3-4
 - Long header11-14
 - LOSHA4-5, 10-2
 - LXAV4-5
 - LXE1-8
 - LXep,d1-8
 - LXeq1-8
 - LXpk1-9
 - LXpkMax6-4
 - LXpkmax1-9
 - LXYav41-8
 - LXYav51-8
 - LXYinst1-8
 - LXYmax1-8
 - LXYmin1-8
 - LXYp1-8
- M**
- Maintenance and repair8-2
 - Measurement
 - Control Window4-6
 - data1-13, 6-3
 - parameters1-7, 11-34
 - range1-12, 2-9, 2-11, 4-3, 9-2, 9-5
 - Result pushkey1-11, 2-9, 2-13, 3-3
 - settings3-2, 4-2
 - set-up1-13, 4-12, 6-3
 - set-up (default)4-13
 - Set-up menu1-10, 1-11, 2-9, 4-2
 - Window ... 1-7, 1-10, 2-2, 2-5, 2-9, 2-10, 3-3,4-4, 5-11
 - Memory1-12, 1-13, 9-4
 - Menu
 - items (selecting)2-9
 - keys1-10
 - structure1-10
 - Message
 - compound11-4
 - from the Mediator11-6
 - header11-4
 - joining11-5
 - sub-header11-4
 - syntax11-6
 - terminator11-4, 11-9
 - to the Mediator11-4
 - Messages and warnings10-5
 - Microphone1-4, 5-3, 9-2
 - extension cable2-7, 5-2
 - preamplifier1-4, 9-2
 - type6-3
 - Minimum code (mnemonics)11-6, 11-8
 - Mnemonics11-6, 11-7, 11-8
 - Modem3-6
- N**
- Navigation1-10
 - Noise Explorer7-4, 11-15
 - Non-volatile memory1-13
 - NR1, NR2, NR311-10
 - Null-modem cable1-4
 - Number of
 - data files1-13, 6-2
 - peaks1-9, 6-4
 - Numbering files6-2
 - Numeric data11-9, 11-10
- O**
- Occupational Health
 - parameters4-11
 - Window4-11
 - Octave filters1-5
 - Operating time2-3
 - OSHA10-2
 - Output
 - AC7-6
 - DC7-6
 - Overall results6-3
 - Overload2-11, 4-4, 6-4, 9-3
 - warning4-4
 - Overload%1-9
- P**
- Parameter1-7
 - changing the displayed5-11
 - default10-4
 - fields2-12
 - header11-8
 - selecting2-9
 - text1-3
 - Parameter? query11-29
 - Pause
 - Continue pushkey2-10
 - mode2-5, 2-8, 2-9, 3-2, 6-4, 11-32
 - PAUse command11-32
 - Peak
 - detector1-5
 - data1-14, 6-3, 6-4
 - weighting4-5, 11-25
 - Peaks Over
 - indication4-4
 - value4-4

- Peaks_Over command 11-36
 Peaks_Over? query 11-38
 Power pushkey 2-8
 Prepolarized microphone 1-4, 5-3, 9-2
 Preset Time 4-7
 Preset_Time command 11-36
 PReset_Time? query 11-38
 Print
 a measurement 7-3
 files 6-6, 6-8
 Options list 6-5
 Window 6-8
 Printer
 interface parameters (setting up) 3-6
 Interface Window 3-6
 Program message
 terminator 11-5, 11-9
 unit separator 11-5
 Protective cover 1-4
 Protector 7-4, 11-15
 Protocol 11-13
 Pushkeys
 Backlight 2-10
 Calibrate 2-8
 Cancel 2-10
 Data Files 2-8
 definitions 2-8
 Left/Right Arrow 2-9
 Meas. Result 11-27
 numbering 11-27
 Pause/Continue 2-10
 pictograms 1-3, 2-8
 Power 2-8
 Range 2-9
 Reset 2-9
 Select 2-10
 Set-up 2-9
 System 2-8
 Up/Down Arrow 2-9
Q
 Quasi-analogue display 2-10, 4-4
 Query 11-11, 11-13
 Auto_Start_1...4? 11-38
 Aux_1? 11-38
 Aux_1_FW? 11-38
 Aux_2? 11-38
 Criterion_Level? 11-38
 Error? 11-18
 Exchange_Rate? 11-38
 Exposure_Time? 11-38
 File_Copy 11-19
 File_DELETE 11-20
 File_Directory 11-21
 File_Save 11-23
 File_Space? 11-22
 Frequency_Weighting_1? 11-24
 Frequency_Weighting_2? 11-25
 Identify 11-26
 message overview 11-16
 messages 11-16
 PParameter? 11-29
 Peaks_Over? 11-38
 PReset_Time? 11-38
 Random_Frontal? 11-38
 RAnge? 11-33
 SEquence? 11-38
 SEtup? 11-37
 STatus? 11-39
 SYstem? 11-40
 Threshold_Level? 11-38
 Version? 11-41
 Wind_Screen? 11-38
R
 Random_Frontal command 11-36
 Random_Frontal? query 11-38
 Range
 pushkey 1-12, 2-9, 4-4
 setting 2-11
 Setting window 4-4
 RAnge command 11-32
 RAnge? query 11-33
 Recall
 files 6-8
 Files Window 6-8
 measurement set-up 4-12, 4-13
 Setup Window 4-13
 Recall command 11-36
 Rechargeable batteries 2-3
 Repair 8-2
 REset command 11-34
 Reset pushkey 2-9
 Resolution 9-3
RMS
 detector 1-5, 4-9
 weighting 4-5
 Root header 11-4
 RS-232 interface 1-4
 Run/Pause indicator 2-12
S
 SAvE command 11-37
 Save Setup Window 4-12
 Saved data 6-3
 Saving
 current meas. set-up 4-12
 measurement set-ups 4-12
 Select pushkey 2-10
 Selecting
 Data Files menu 6-4
 menu items 2-9
 parameters 2-9, 3-3
 Sensitivity value 5-2, 6-3

Index

- SEquence command11-37
 - SEquence? query11-38
 - Serial
 - input/output9-4
 - interface11-4
 - cable1-4
 - parameters3-5
 - socket7-2, 7-5, 11-15
 - Interface Window3-5
 - number1-13, 6-3
 - printer9-4
 - Setting up
 - Auto Start4-9, 4-11
 - bandwidth for Detector 14-5
 - Baud Rate3-5
 - computer interface11-15
 - contrast3-7
 - correction filters4-7
 - Criterion Level4-12
 - date and time3-4
 - Exposure Time4-11
 - frequency weighting4-5, 4-8
 - general measurement parameters4-3
 - Handshake3-6
 - input/output function4-8
 - interface parameters3-5
 - Language3-7
 - measurement range2-9
 - Mediator to start automatically5-10
 - Occupational Health parameters4-11
 - Preset Time4-7
 - start time for Auto Start4-10
 - Threshold Level4-12
 - windscreen filter4-8
 - Setting time9-4
 - Set-up
 - data1-14, 6-3
 - pushkey2-9
 - SEtup command11-34
 - SEtup? query11-37
 - Short header11-14
 - Shoulder bag1-4, 8-3
 - Slow (S)1-5
 - Socket
 - External Power2-4
 - reference to1-3
 - Soft keys1-3, 1-10, 3-3, 4-2
 - Software package11-19
 - Sound incidence
 - frontal4-7
 - random4-7
 - SPL5-11
 - Standards1-4, 9-2, 9-4
 - Window3-8
 - Start
 - date6-3
 - time6-3
 - STatus? query11-39
 - Store files6-5
 - Storing Mediator8-2
 - String data11-9, 11-12
 - Sub-header11-4
 - Summary of contents1-2
 - Switching
 - a sequence On/Off4-7
 - Mediator On/Off2-5, 2-8
 - Syntax diagrams11-6, 11-7
 - System
 - information3-8
 - key3-3, 4-2
 - menu1-7, 1-10, 1-11, 2-8, 3-2
 - pushkey2-8
 - SYstem command11-40
 - SYstem? query11-40
- T**
- Tag
 - files6-7
 - parameters6-6
 - Terminator11-4, 11-9
 - Threshold level4-12
 - Threshold_Level command11-37
 - Threshold_Level? query11-38
 - Time1-10
 - weighting1-5, 1-7, 5-11
 - Transmission time11-7
 - Types of data11-9
- U**
- Under-range2-10, 6-4
 - Underrange%1-9
 - Unknown command11-8
 - Up/Down Arrow pushkey2-9
- V**
- Value fields2-12
 - Version? query11-41
- W**
- Weight and dimensions9-4
 - Weightings Window4-5, 5-10
 - Wind_Screen command11-37
 - Wind_Screen? query11-38
 - Windscreen5-3
 - filter4-8
 - Word concatenator11-8
- X**
- X suffix1-7
- Y**
- Y suffix1-7